

Intellian

GX60

Installation and Operation User Guide

Serial number of the product

This serial number will be required for the all troubleshooting or service inquiries.

Intellian

© 2019 Intellian Technologies Inc. All rights reserved. Intellian and the Intellian logo are trademarks of Intellian Technologies, Inc., registered in the U.S. and other countries. The v-Series and the GX60 are trademarks of Intellian Technologies, Inc. Intellian may have patents, patent applications, trademarks, copyrights, or other intellectual property rights covering subject matter in this document. Except as expressly provided in any written license agreement from Intellian, the furnishing of this document does not give you any license to these patents, trademarks, copyrights, or other intellectual property. Global Xpress Service™ or GX™ is a trademark of Inmarsat PLC and refers to Inmarsat's fixed and mobile, land, maritime and aero Inmarsat 5 Ka-band satellite services. All other logos, trademarks, and registered trademarks are the property of their respective owners. Information in this document is subject to change without notice. Every effort has been made to ensure that the information in this manual is accurate. Intellian is not responsible for printing or clerical errors.

Disclaimer

The information in this user manual is subject to change without prior notice through a product life cycle. A printed version of the user manual is periodically updated and may contain inaccuracies or omissions compared to the recent product information. The most up-to-date information can be readily accessible on a supplied USB memory stick or on our website at <http://www.Intelliantech.com>.

General Precautions

Before you use the antenna, make sure that you have read and understood all safety requirements.





	<p>THIS WAY UP</p> <ul style="list-style-type: none">• Place the boxes/crates on the floor noting the direction of the arrow.
	<p>FRAGILE</p> <ul style="list-style-type: none">• Since the Radome is fragile, handle it with care. Do not apply excessive pressure or shock. These may cause surface cracking or other damage.
	<p>DO NOT STACK</p> <ul style="list-style-type: none">• Do not stack boxes/crates as there is a risk boxes/crates may fall and be damaged.
	<p>KEEP DRY</p> <ul style="list-style-type: none">• Always make sure the antenna is stored on a dried floor.• The antenna can withstand ordinary rain. However its water resistance cannot be guaranteed if submerged.• Keep the antenna in a dried place for sufficient ventilation. Do not store the antenna wrapped in a tarp, tent, vinyl, and others.

Table of Contents

Certifications	8
Introduction	12
Intellian GX60 Introduction	12
Intellian GX60 Features	13
System Configuration	14
Tools Required for Installation	15
Installing Antenna	16
System Package	16
Antenna Unit	17
BDT (Below Deck Terminal)	18
Installation Kit	19
Planning Installation	20
Selection of Antenna Installation Site	20
Minimize Satellite Blockage	20
Avoid RF Interference	21
RF Hazard Precautions	21
Antenna Dimensions	22
Antenna Mounting Templates	23
Antenna Mounting Hole Pattern	24
Mast Design Recommendation	25
Mast Designing (Installation Example)	26
Position Radome	27
System Cables	28
RF Cable (Customer Supplied)	28
Labeling RF Cables	29
Power Cable (Customer Supplied)	29
Placing Cables on Mast	30
Power Connector Termination	31
Antenna Installation	32
Unpacking Wooden Crate	32
Placing Antenna on Mast	37
Connecting Cables (Customer Supplied)	38
Mounting Radome	39
Turning on Power Switch	40
Installing BDT	42

Mounting BDT	42
19" Rack Mount Type	42
Table Mount Type	42
BDT Dimensions	43
Selection of BDT Installation Site	43
Connecting Cables to BDT	44
RF Cable Connection	44
Ship Gyrocompass Connection	45
Recommended Cable	45
PC to BDT Communication Setup	46
TCP/IP Connection	46
Wi-Fi Connection	46
Checking Modem Information	47
One-touch Commissioning	48
BDT Connector Guide	49
<i>Operating BDT</i>	<i>51</i>
Introduction	51
Normal Mode	52
Startup	52
Monitoring Current Antenna Status	53
Setup Mode	56
Antenna Settings	57
Manual Search	57
Antenna Diagnostic Test	58
Satellite Settings	60
Load Satellite	60
System Settings	61
Set Location	61
Management	63
<i>Using Aptus PC</i>	<i>64</i>
Introduction	64
Hardware	64
Operating System and Software	64
Software Installation	65
PC to BDT Communication Setup	66
Starting Aptus®	66
Establish Data Communication	67
Auto Update	68
Toolbar Menus	69
System Property Status Dashboard	72
Work View Tabs	75

1. Antenna – Basic Info.....	75
2. Antenna – Advanced Info.	76
3. Satellite.....	79
4. Graph View.....	81
5. Monitor.....	82
6. Diagnostic / Modem.....	83
7. GUI.....	84
8. Work View Functions.....	85

***Using Aptus Web*..... 89**

Introduction	89
Main Page	90
Page Login.....	90
Top Menus	91
Dashboard & Information	92
Antenna Settings	94
Ship Setting.....	94
Antenna Setting.....	95
Tracking Setting.....	97
Diagnostic.....	98
Library Setting.....	99
Firmware & Configuration	100
Antenna Firmware Upgrade.....	100
Antenna Log.....	102
Antenna Backup & Restore.....	104
Administration	105
Network Setting.....	105
User Management.....	107
iARM Upgrade.....	108
iARM Save & Reboot.....	109
Antenna Event Log.....	110
Modem Information.....	111

***Technical Specification*..... 112**

***Warranty*..... 113**

Certifications

FCC Part 15 Subpart B Declaration of Conformity (DoC)

We, Intellian Technologies, Inc. located at 18-7, Jinwisandan-ro, Jinwi-myeon, Pyeongtaek-si, Gyeonggi-do 451-862, Korea, declare that the product described below to which this declaration relates is in conformity with the requirement of the FCC Part 15 Subpart B.

Product Information:

Product Name:	Intellian GX60, 65cm Ka-band Maritime Stabilized Antenna System
----------------------	---

Test Result:

Standard	Test	Rule section	Test Report Number	Result
FCC Part 15 Subpart B	AC power line conducted emission	Section 15.107(a) ICES-003, Section 6.1, Table 2	SKT-EFC-140043	Pass
	Radiation emissions below 1GHz	Section 15.109(a) ICES-003, Section 6.2, Table 5	SKT-EFC-140043	Pass
	Radiation emissions above 1GHz	Section 15.109(a) ICES-003, Section 6.2.2, Table 7	SKT-EFC-140043	Pass

Supplementary Information:

Notified Body Involved: (Testing Organization)	SK Tech Co., Ltd. 820-2, Wolmoon-ri, Wabu-up, Namyangju-si, Gyeonggi-do 482-905, Korea
Technical/Compliance File Held by:	Intellian Technologies, Inc. 18-7, Jinwisandan-ro, Jinwi-myeon, Pyeongtaek-si, Gyeonggi-do 451-862, Korea
Place and Date of issue:	Gyeonggi-do, Korea on September 1, 2014

Authority: Kevin Eom/
Director,
Research and Development

Signature: 

Date: September 01, 2014

Intellian Technologies USA, Inc.
US Headquarters
9004 Research Drive
Irvine, CA 92618 USA
Tel: +1 949 727 4498

Intellian Technologies, Inc.
EMEA & APAC Headquarters
18-7, Jinwisandan-ro, Jinwi-myeon, Pyeongtaek-Si,
Si,
Gyeonggi-do 451-862, Korea
Tel: +82 2 511 2244

Doc Number IT14-DC0901-03

RED Declaration of Conformity (DoC)

We, Intellian Technologies, Inc. located at 18-7, Jinwisandan-ro, Jinwi-myeon, Pyeongtaek-si, Gyeonggi-do 451-862, Korea declare under our sole responsibility that the product(s) described in the below to which this declaration relates is in conformity with the *essential requirements* and *other relevant requirements* of the Radio Equipment Directive (2014/53/EU).

Product Information:

Product Name(s):	Intellian GX60, 65cm Ka-band Maritime VSAT Antenna System
-------------------------	---

To provide the presumption of conformity in accordance to Annex III(encompassing Annex II) of Directive 2014/53/EU; the following harmonized standards and normative documents are those to which the product's conformance is declared, and by specific reference to the essential requirements of Article 3 of the Directive 2014/53/EU.

1995/5/EC Article	Standard(s) Applied in Full	Result
SAFETY (Art 3.1.a)	EN 60950: A2	Pass
EMC (Art. 3.1.b)	EN 301 843-1	Pass
SPECTRUM (Art. 3.2)	EN 301-360 EN 301-459 EN 303-978	Pass

Supplementary Information:

Notified Body Involved: (Testing Organization)	DT&C Co., Ltd. 42, Yurim-ro, 154 beon-gil, Cheoin-gu, Yongin-si, Gyeonggi-do 449-935, Korea
Technical/Compliance File Held by:	Intellian Technologies, Inc. 18-7, Jinwisandan-ro, Jinwi-myeon, Pyeongtaek-Si, Gyeonggi-Do 451-862, Korea
Place and Date of issue:	Gyeonggi-do, Korea on 20 Oct 2012

Authority: Steve Cha
/ CTO, R&D

Signature:  _____

Date: 20th July, 2017

Intellian Technologies USA, Inc.
US Headquarters
11 Studebaker
Irvine, CA 92618 USA
Tel: +1 949 727 4498

Intellian Technologies, Inc.
EMEA & APAC Headquarters
348-5 Chungo-Ri, Jinwi-Myeon
Pyeongtaek-Si, Gyeonggi-Do, 451-862 Korea
Tel: +82 31 379 1000

Doc Number IT16-DC0502-03

C-Tick Declaration of Conformity (DoC)

We, Intellian Technologies, Inc. located at 18-7, Jinwisandan-ro, Jinwi-myeon, Pyeongtaek-si, Gyeonggi-do 451-862, Korea, declare that the product described below to which this declaration relates is in conformity with the *essential requirements* and *other relevant requirements* of the C-Tick.

Product Information:

Product Name:	Intellian GX60, 65cm Ka-band Maritime Stabilized Antenna System
----------------------	---

Test Result:

Standard	Test	Test Report Number	Result
AS/NZS CISPR 22 CISPR 22 EN 55022	Conducted disturbance at AC main port	SKT-EET-140040	Pass
	Conducted disturbance at telecommunication port	SKT-EET-140040	Pass
	Radiated disturbance below 1GHz	SKT-EET-140040	Pass
	Radiated disturbance above 1GHz	SKT-EET-140040	Pass

Supplementary Information:

Notified Body Involved: (Testing Organization)	SK Tech Co., Ltd. 820-2, Wolmoon-ri, Wabu-up, Namyangju-si, Gyeonggi-do 482-905, Korea
Technical/Compliance File Held by:	Intellian Technologies, Inc. 18-7, Jinwisandan-ro, Jinwi-myeon, Pyeongtaek-si, Gyeonggi-do 451-862, Korea
Place and Date of issue:	Gyeonggi-do, Korea on September 1, 2014

Authority: **Kevin Eom/
Director,
Research and Development**

Signature: 

Date: September 01, 2014

Intellian Technologies USA, Inc.
US Headquarters
9004 Research Drive
Irvine, CA 92618 USA
Tel: +1 949 727 4498

Intellian Technologies, Inc.
EMEA & APAC Headquarters
18-7, Jinwisandan-ro, Jinwi-myeon, Pyeongtaek-Si,
Si,
Gyeonggi-do 451-862, Korea
Tel: +82 2 511 2244

Doc Number IT14-DC0901-01

EMI Declaration of Conformity (DoC)

We, Intellian Technologies, Inc. located at 18-7, Jinwisandan-ro, Jinwi-myeon, Pyeongtaek-si, Gyeonggi-do 451-862, Korea, declare that the product described below to which this declaration relates is in conformity with the *essential requirements* and *other relevant requirements* of the IEC60945 and IEC61000-4-2~6/11.

Product Information:

Product Name:	Intellian GX60, 65cm Ka-band Maritime Stabilized Antenna System
----------------------	---

Test Result:

Standard	Ref. Clause	Test suite	Result
IEC60945	9.2	Conducted emissions at main port	Pass
	9.3	Radiated emissions below 30 MHz	Pass
	9.3	Radiated emissions below 1 GHz	Pass
	9.3	Radiated emissions above 1 GHz	Pass
IEC61000-4-2	10.9	Electrostatic discharge (ESD)	Pass
IEC61000-4-3	10.4	Radiated immunity (RS)	Pass
IEC61000-4-4	10.5	EFT/Burst on AC power ports, and signal and control ports	Pass
IEC61000-4-5	10.6	Surge immunity on AC power ports	Pass
IEC61000-4-6	10.3	Injected current (CS) on AC and DC power ports, signal and control ports	Pass
IEC61000-4-11	10.7	Power supply short term variation on AC power ports	Pass
IEC61000-4-11	10.8	Power supply failure on AC and DC power ports	Pass

Supplementary Information:

Notified Body Involved: (Testing Organization)	SK Tech Co., Ltd. 820-2, Wolmoon-ri, Wabu-up, Namyangju-si, Gyeonggi-do 482-905, Korea
Technical/Compliance File Held by:	Intellian Technologies, Inc. 18-7, Jinwisandan-ro, Jinwi-myeon, Pyeongtaek-si, Gyeonggi-do 451-862, Korea
Place and Date of issue:	Gyeonggi-do, Korea on September 1, 2014

Authority: Kevin Eom/
Director,
Research and Development

Signature: 

Date: September 01, 2014

Intellian Technologies USA, Inc.
US Headquarters
9004 Research Drive
Irvine, CA 92618 USA
Tel: +1 949 727 4498

Intellian Technologies, Inc.
EMEA & APAC Headquarters
18-7, Jinwisandan-ro, Jinwi-myeon, Pyeongtaek-Si,
Si,
Gyeonggi-do 451-862, Korea
Tel: +82 2 511 2244

Doc Number IT14-DC0901-02

Introduction

Intellian GX60 Introduction

Intellian GX60 is a 65 centimeter Ka-band maritime stabilized antenna, a ready-to-use system for the super-fast, Global Xpress™ (GX) Ka-band broadband service from Inmarsat. The GX60 offers robust Ka-band RF performance optimized for Inmarsat GX service with all new GX BDT.

The GX60 BDT combines the Global Xpress Modem internally with the Below Deck Terminal, saving time and space during installation. The BDT also includes Wi-Fi to allow wireless connection using the dedicated Intellian Aptus software for system control and monitoring.

The Aptus software automatically configures the antenna system, enabling true One Touch Commissioning. Equipped with Aptus®, the GX60 antenna can be remotely accessed, monitored and controlled through serial connection or secured TCP/IP network. Its graphic-based user interface provides easy-to-use operating environment.

The GX60 also has an embedded web server and secured web user interface called Aptus Web for remote management of the antenna on a web browser. Network connection can be easily setup through the front Management Ethernet Port on the BDT that supports automatic IP configuration.

The antenna's 3-axis stabilized platform and advanced shock-resistant and vibration damping design of the Pedestal is fully optimized to withstand the demanding maritime conditions and to ensure reliable broadband communications. The unlimited azimuth range ensures continuous tracking without unwrapping the cables in the antenna and the low elevation angle (-20°) supports seamless signal reception at extremely high latitudes.

The GX60 is built to meet or exceed the industry's most stringent standards such as FCC, ETSI, R&TTE. With its frequency tuned radome and newly designed reflector, the GX60 offers the maximized performance on a Ka-band Inmarsat Global Xpress system.

Intellian GX60 Features

Ka-band optimized reflector

The GX60 carbon fiber reflector is designed and engineered to operate on the Ka-band while maximizing the RF performance. The reflector of the GX60 is designed to be extremely precise and very stable in all operating conditions.

Frequency tuned radome

To ensure efficient operations for Ka-band Inmarsat Global Xpress™ systems, the signal loss of the radome itself is minimized and the performance maximized with an optimized radome design that enhances the Ka-band system performance.

Combined BDT-Global Xpress™ Core Module

The all new GX BDT combines the Core Module internally with the Below Deck Terminal, saving time and space during installation. The BDT also includes a Wi-Fi connection to allow wireless connectivity via the dedicated Intellian Aptus software for system control and monitoring. The Aptus software also helps automatically configure the antenna system during initial commissioning.

Gyro-free satellite search capability

Intellian's new generation gyro-free satellite search function enables the GX60 to acquire and lock onto the satellite without requiring a separate input from the ship's gyrocompass.

Graphical and user-friendly antenna control software: Aptus®

The GX60 provides a newly developed, graphic-based antenna remote control program with an additional Software Development Kit (SDK), allowing the NOC or service center to integrate antenna monitoring and control into its existing network management systems in an easier, user-friendly, and convenient manner.

Dedicated Management Ethernet Port

The GX60 has a Management Ethernet Port on the BDT front that enables direct and simple network connection between a PC and the BDT. The Management Port allows Internet access and quick access to Intellian's remote management solution, the Aptus Web.

Wireless access via Wi-Fi

The built-in Wi-Fi wireless network card enables the BDT to be wirelessly connected and can be turned on and off by a switch. Wireless devices such as PCs, laptops and smartphones can be used to connect to the BDT and monitor, enabling users to control and change the settings of Intellian antenna system wirelessly.

Industry-leading standards compliance

The GX60 is designed to meet or exceed FCC and ETSI specifications, as well as EN60945, EN60950, R&TTE, DNV2.4 Class C specification.

Automatic satellite switching

The GX60 supports auto satellite and beam switching for seamless continuous coverage.

System Configuration

For your satellite communication system to work correctly, the system will have to be connected with all of the provided components as shown in the figure below. A separate purchase of a satellite modem and ship's gyrocompass may be required.

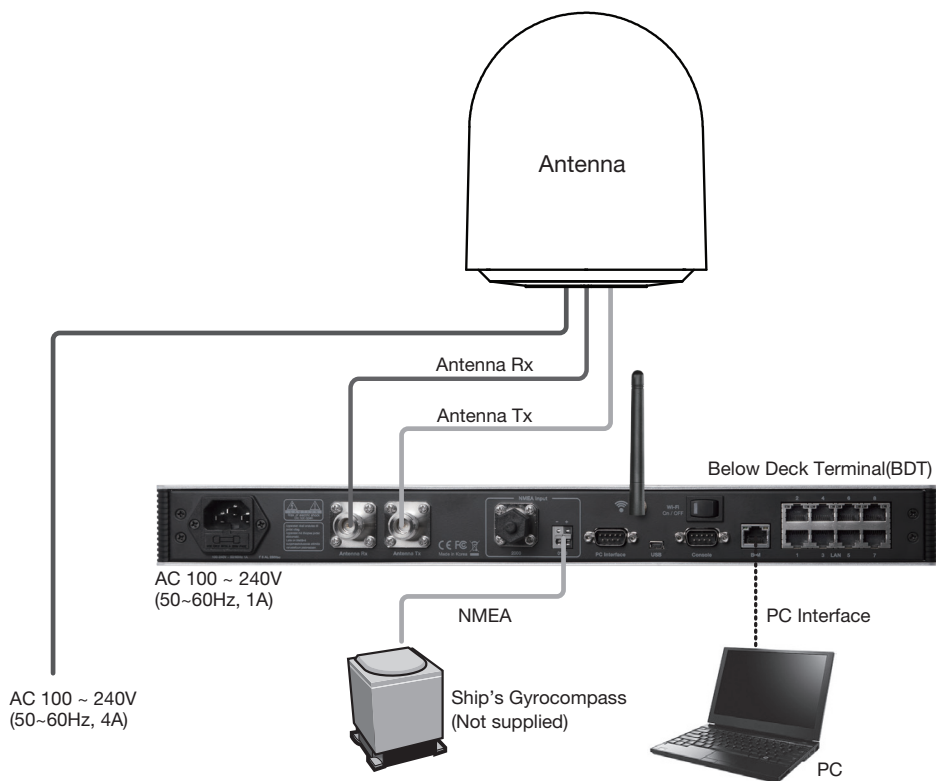

Tools Required for Installation

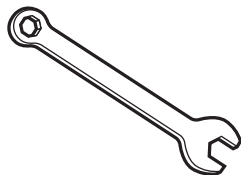

11 mm Wrench

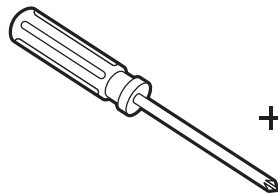

Phillips Head Screwdriver

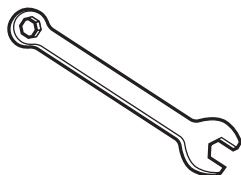

19 mm Wrench

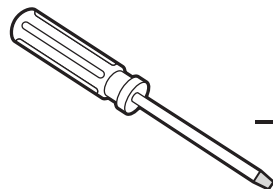

Flat Head Screwdriver

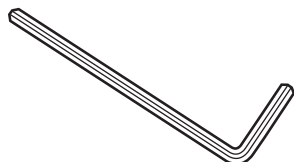

5 mm Allen/Hex key

Installing Antenna

System Package

The package of Intellian GX60 consists of antenna unit, BDT and installation kit box.

Antenna unit



BDT



Installation kit box

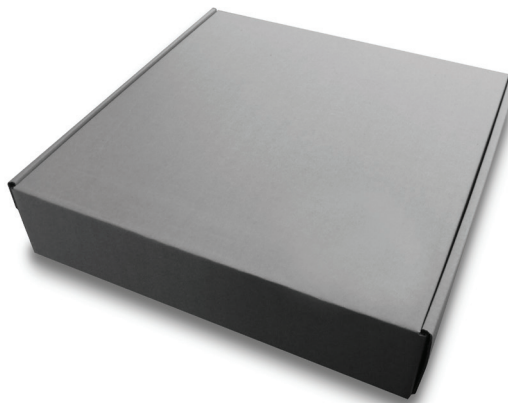

Antenna Unit

The antenna unit includes an antenna pedestal inside a radome assembly unit. The pedestal consists of a satellite antenna main dish with RF components mounted on a stabilized pedestal. The radome protects the antenna pedestal assembly unit from the severe marine environment.

Antenna unit



BDT (Below Deck Terminal)

The digital VFD (Vacuum Fluorescent Display) allows for easy operation of the BDT, even in the dark.

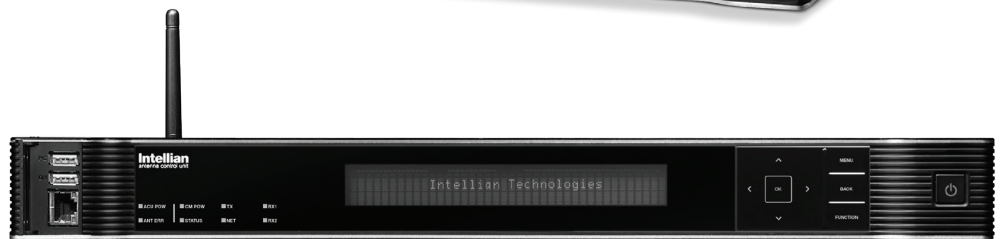

Front Panel



Rear Panel

The functions of the BDT are as follows :

- Setting the satellite
- Editing satellite information
- Setting the antenna parameter
- Setting the antenna manual search
- Setting the LNB local frequency
- Setting block zones
- Setting GPS and Gyrocompass
- Display versions
- Built-in real-time diagnostics function
- Backup and restore the system settings
- Set up the interface with a PC
- Supports Wi-Fi BDT operation
- Recording antenna activities and firmware upgrade through USB
- Built-in web-based remote control management
- Front and rear panel Management Ethernet port

Installation Kit

Contains the items required for securing the antenna unit and BDT to the vessel.

BDT box			
Description	Q'ty	Size	Remarks
Below Deck Terminal (BDT)	1	43.1 cm x 44.1 cm x 4.4 cm (17" x 17.3" x 1.7")	Below Deck Terminal
User Manual	1		
RF Hazard Sticker	1		Radiation Safety Distance Label
Mounting Template	1		
Wi-Fi Antenna	1	110mm	
USB Flash Drive	1		

Components box			
Description	Q'ty	Size	Remarks
BDT Bracket (Rack)	2		BDT-19inch Rack
BDT Bracket (Table)	2		BDT-Table
AC Power Cord (CEEE7/7)	1	1.5m	BDT Power
AC Power Cord (USA)	1	1.5m	BDT Power
4 Pin Power Connector	1	-	CA 3 LD
PC Serial Cable	1	1.8m	BDT to PC
USB Cable (A-A)	1	1.8m	BDT to PC
Ethernet Cable (RJ45/LAN)	1	1.5m	BDT to PC
N to F Adaptor	2		N(Male) to F(Female) Adaptor
Hex Bolt	5	M12 x 100L	
Flat Washer	5	M12	Antenna-Deck 4 Sets : Installation 1 Set : Spare
Spring Washer	5	M12	
Hex Nut	10	M12	
Hex Head Wrench Bolt	5	M6 x 40L	Radome (Spare Bolts)
Spring Washer and Flat Washer	5	M6	
Self-Tapping Screw	5	M4 x 16	Table Mount Bracket
Flat Head Screw	10	M4 x 12L	Rack Mount Bracket BDT
Sems Bolt	5	M3 x 12L	Table Mount Bracket BDT
Radome Door Key	2		1 Door Key and 1 Spare Key

Planning Installation

Selection of Antenna Installation Site

The mounting platform should be robust enough and not subject to vibration. The movement of the antenna can be minimized by installing at the center of the vessel. If these conditions can be only partially satisfied, find the best compromised installation site.

Minimize Satellite Blockage

Install the antenna in accordance with the following procedures to ensure maximum performance of the antenna. The ideal antenna site should have a clear view of the horizon or satellite with all around clearance. Please be sure there are no obstacles within the EL range -20° to $+115^{\circ}$ from the center of the antenna. Obstacles can prevent the antenna from transmitting and receiving the satellite signal.

Elevation Limit
of Obstacles

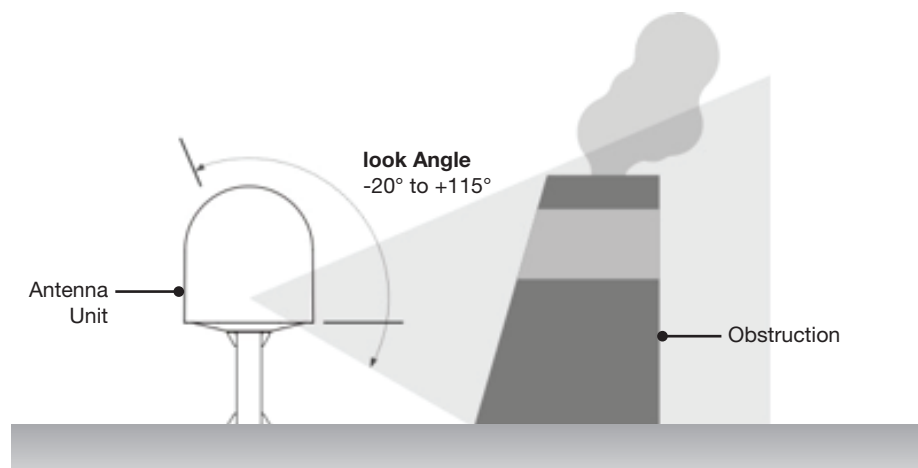

Avoid RF Interference

Do not install the antenna near the high power short wave radar. Most radar transmitters emit RF energy within an elevation range of -15° to $+15^{\circ}$. For this reason, It is recommended to position the antenna at least 15 feet (4.6 m) away from the radar.

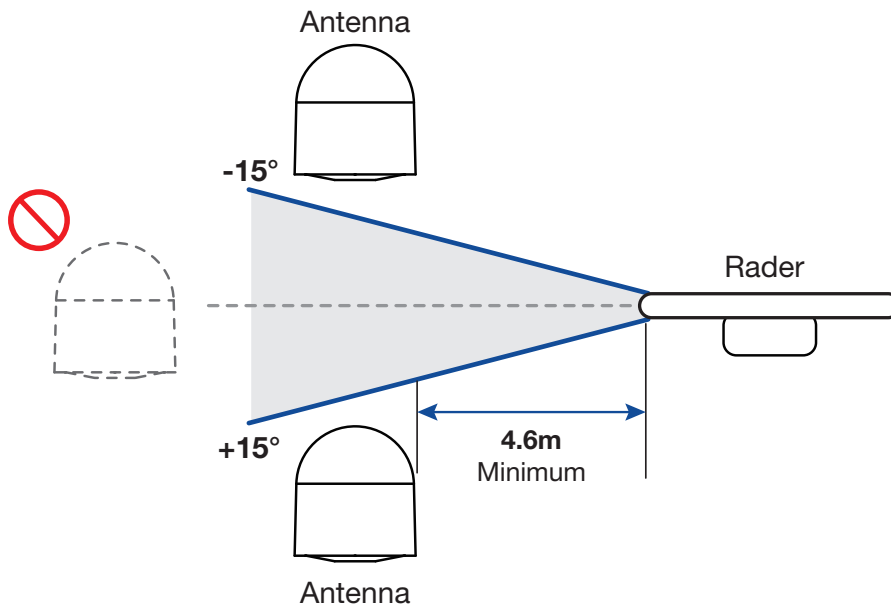

WARNING: Never place the antenna in the beam path of the radar regardless of distance. The high power short wave radar may impair its performance or damage the antenna.

RF Hazard Precautions

The antenna is designed to be used with radiation transmit equipment manufactured by others. Exposure to RF radiation, including exposure associated with an improper use of the transmit equipment, may be hazardous to persons close to the above deck unit. Ensure safety of personnel who work on the system.

During transmission, ensure to keep the minimum safety distance. The recommended minimum safety distance to the reflector on the focal line is about 15m, based on a radiation level of $5\text{mW}/\text{cm}^2$ that applies under occupational/controlled environment. No hazard exists $>20^{\circ}$ below the antenna's mounting plane.

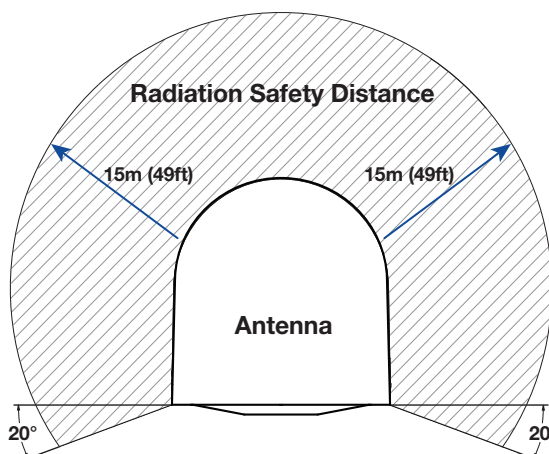

Antenna Dimensions

The method of installation and mounting of antenna may vary with vessel design, but the following procedures are applicable in most situations and will result in a secure and effective installation. Confirm the height and diameter of the antenna before installing it.

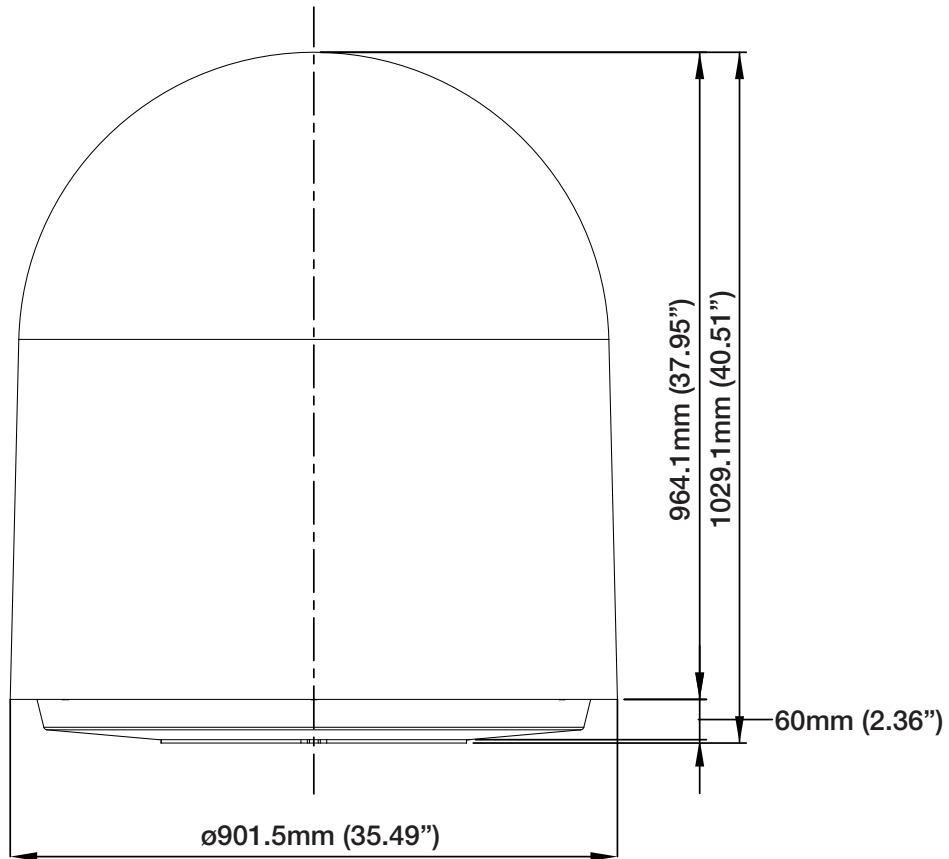

Antenna Mounting Templates

The mounting holes must be in the exact same place as shown in the diagram below.

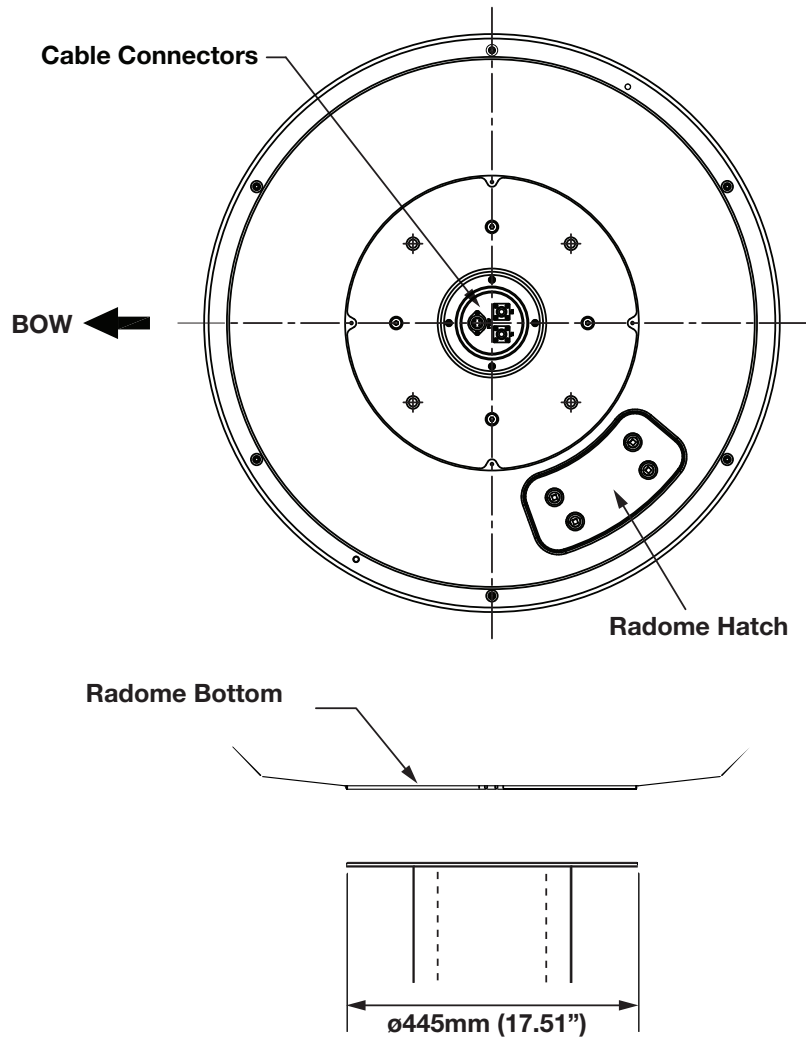

Antenna Mounting Hole Pattern

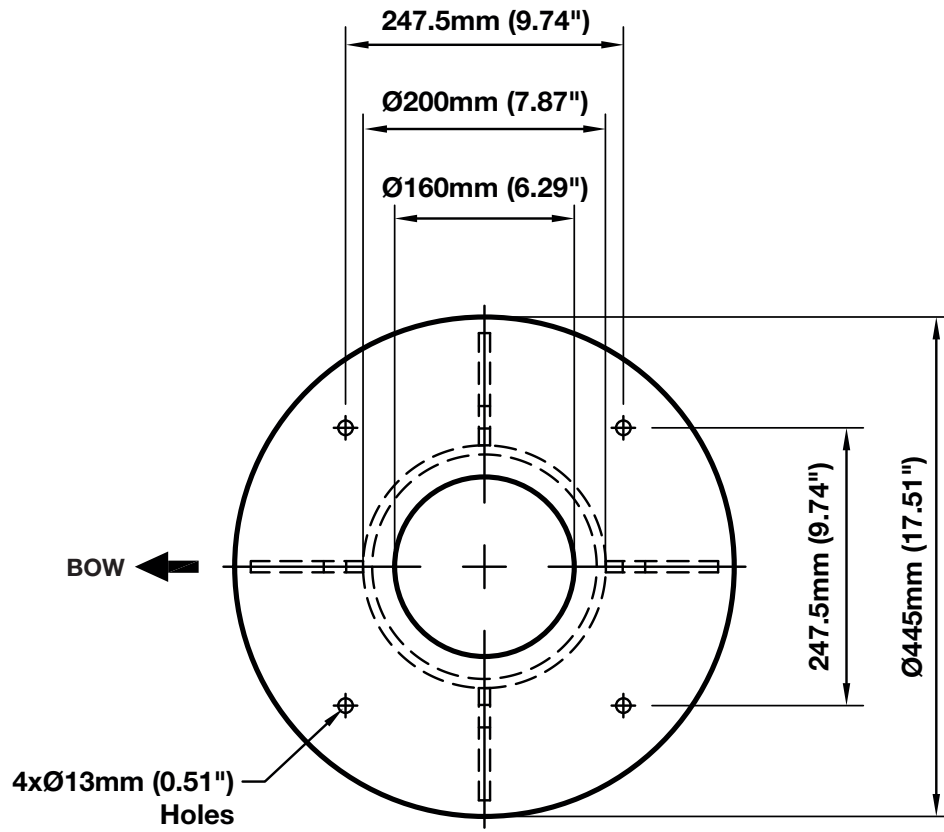

NOTE: The hole ($\text{Ø}160\text{mm}$ (6.29")) in the support pedestal is mandatory for installing the antenna.

Mast Design Recommendation

Intellian strongly recommends installing the antenna less than 1200mm (47") above the deck. If the antenna has to be installed more than 1200mm (47") above the deck, be sure to install it in a safe place where there is enough space to set the radome aside in case of repair. But once again, the best place for the antenna would be less than 1200mm (47") above the deck.

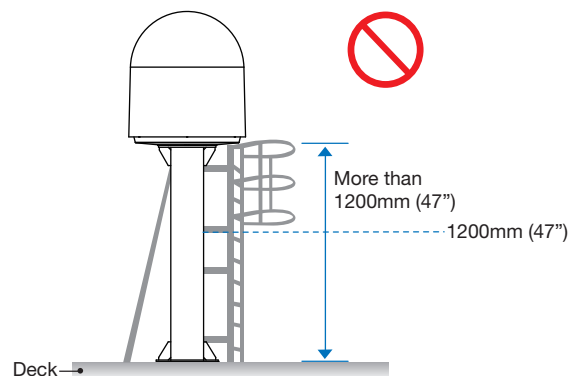
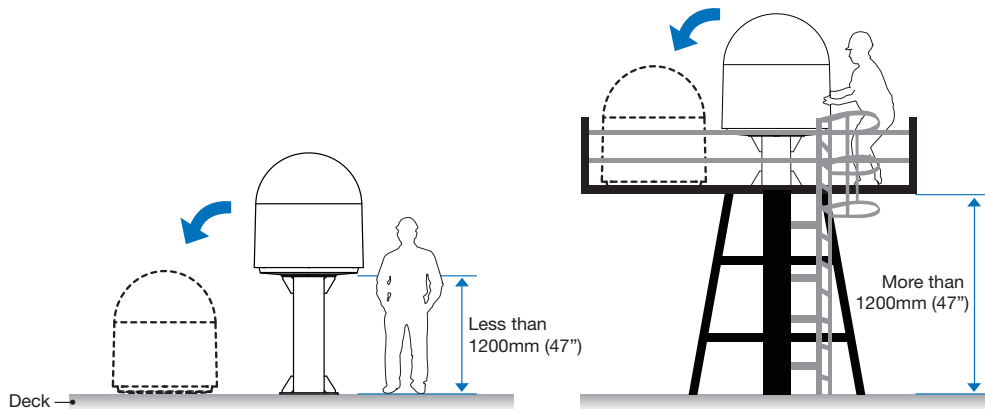

WARNING: Do not install unless you secure enough space to repair. Intellian strongly recommends installing the antenna less than 1200mm (47") above the deck.

Mast Designing (Installation Example)

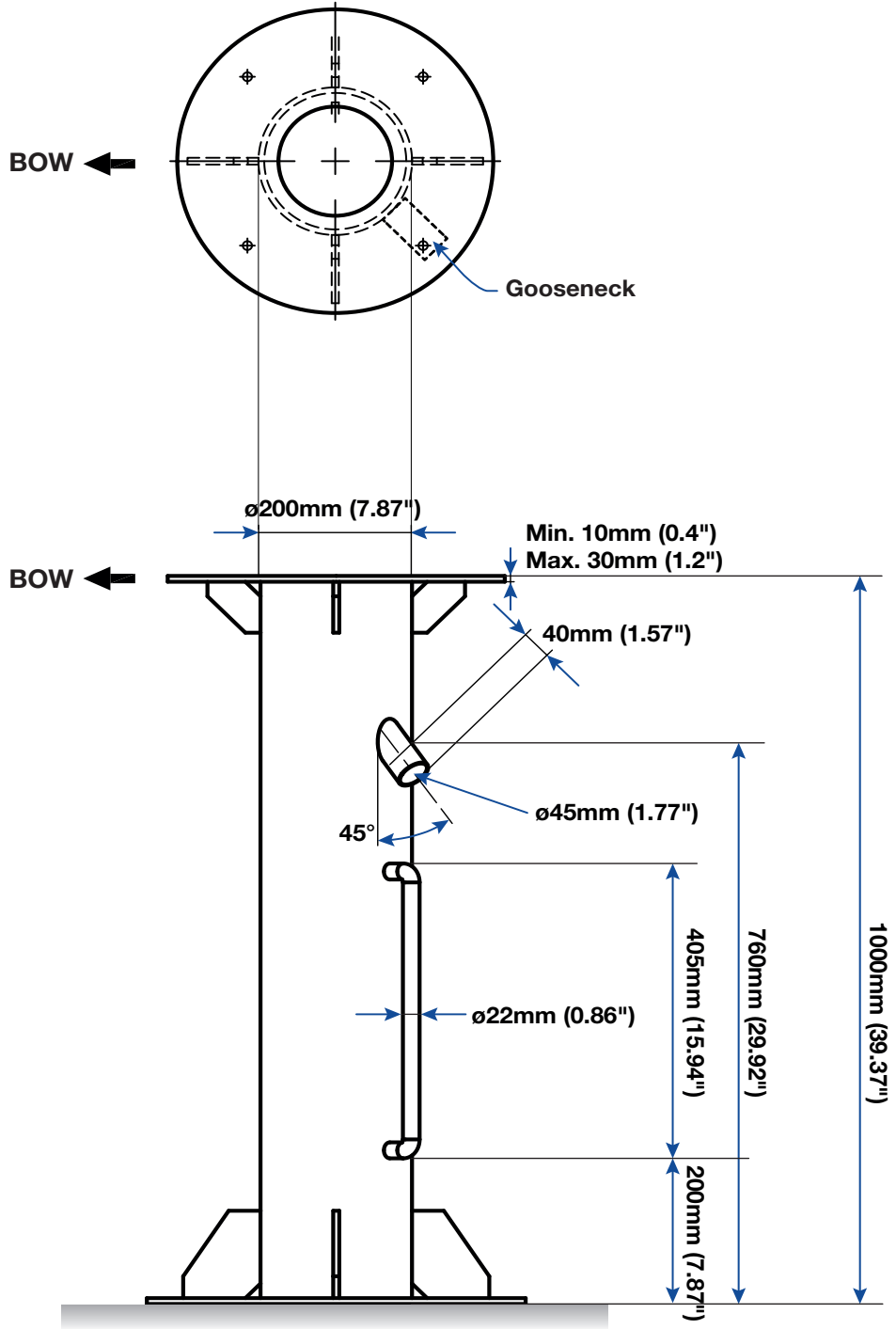

Position Radome

The radome should be positioned with the BOW marker aligned as closely as possible to the ship's centerline.

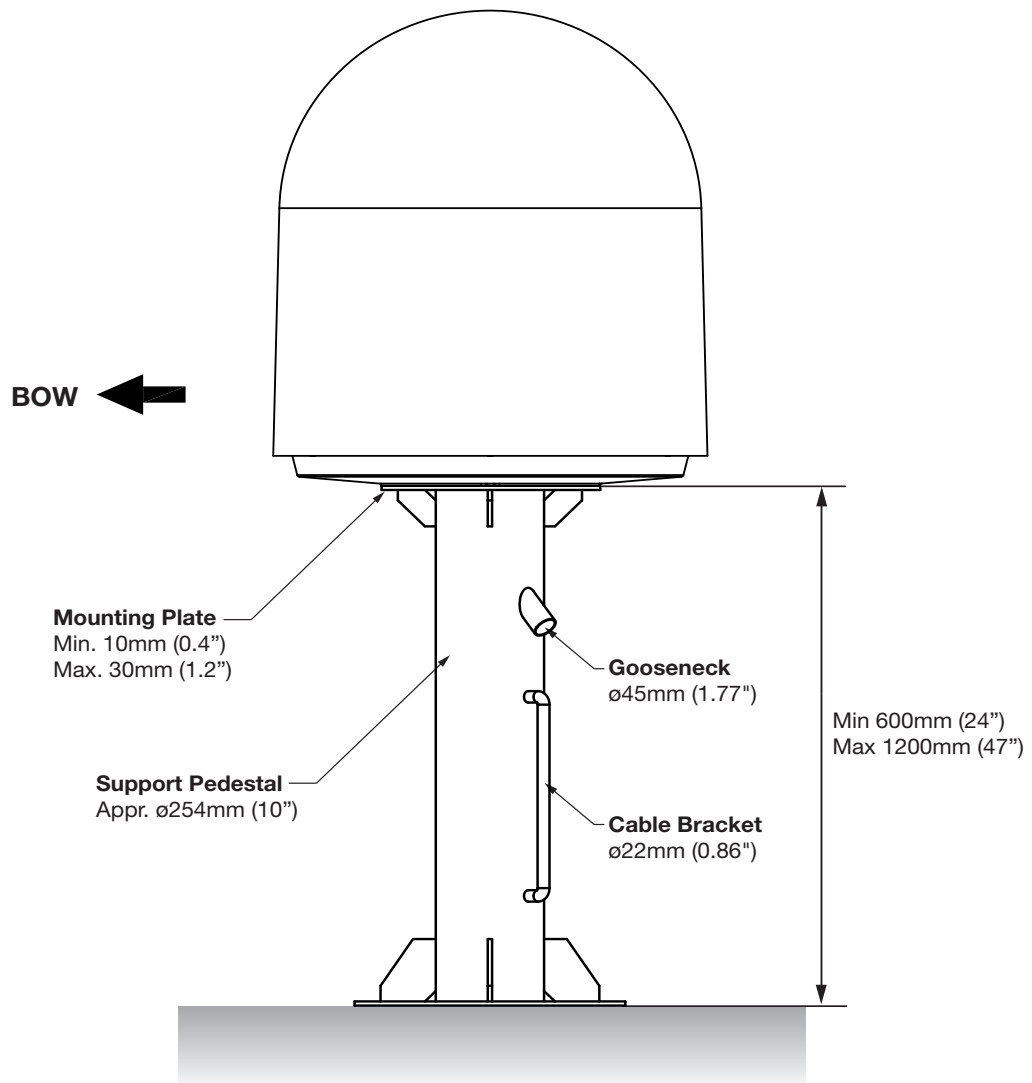

System Cables

Before installing the system cables, you need to take the following points into consideration.

1. All cables need to be well secured and protected from physical damage and exposure to heat and humidity.
2. Cable with an acute bend is not allowed.
3. Where a cable passes through an exposed bulkhead or deck head, a watertight gland or swan neck tube should be used.

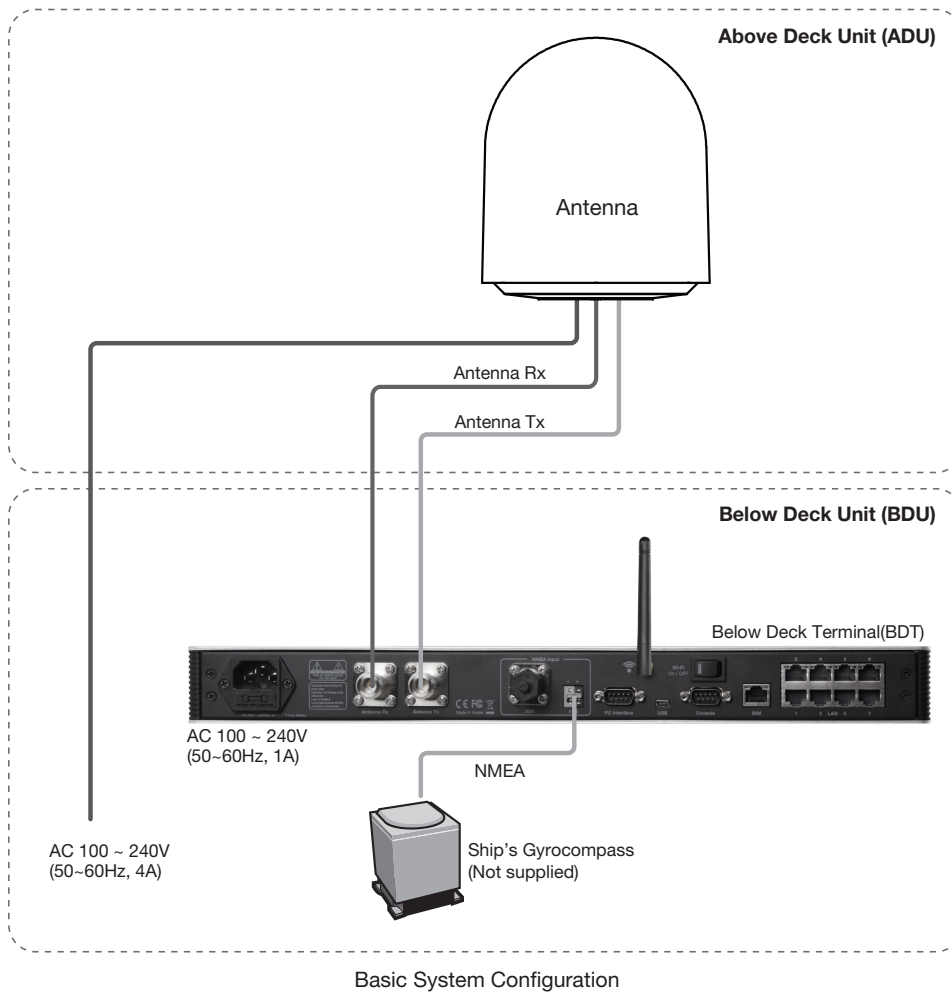

RF Cable (Customer Supplied)

Due to the signal losses across the length of the RF coax on L-Band, Intellian recommends the following 50 ohm coax cable types for standard system installations. For cables that run longer than 100 meters, please consult Intellian Technologies.

Recommended RF Cables

Coaxial Cable Type	Attenuation in dB/100M	Attenuation in dB/M	Recommended Max Cable Length
LMR400	19.6	0.196	60M
LMR600	12.8	0.128	100M

Labeling RF Cables

Once the RF cables are connected to the rear BDT, label Tx or Rx stickers for easy identification.

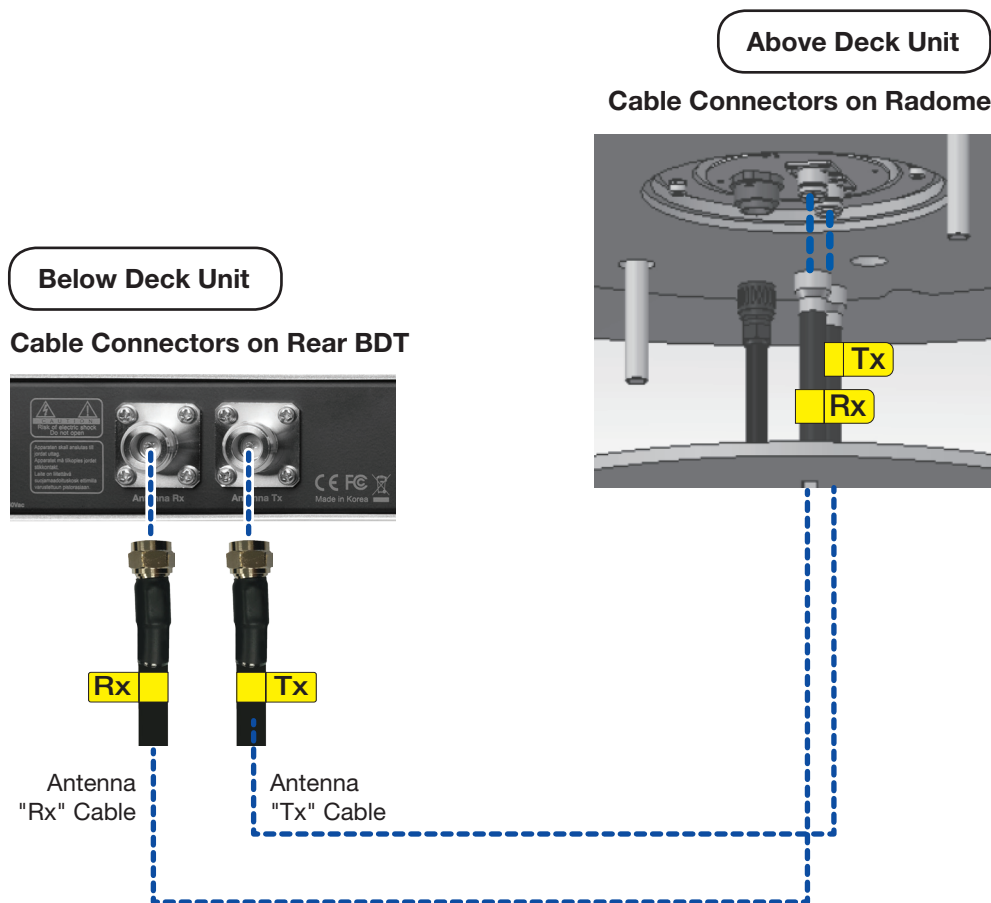

Power Cable (Customer Supplied)

Intellian GX60 has been designed to work on a vessel’s power supply rated at 100-240V AC. Intellian recommends the following size of the input power cable for standard system installations.

Cable Length	Cable Cross Sectional Area	AWG (American Wire Gauge) Size
Up to 100m	2.5mm ²	13
Up to 200m	4mm ²	11

- After connection, seal the cable gland and tie the power cable securely in place.
- The antenna power is supplied from the power switch box equipped with the circuit breakers, and the power switch box should be installed near the antenna.

Placing Cables on Mast

The cables must be routed from the antenna and through various areas of the ship to end up at the Below Deck Terminal. When pulling the cables in place, avoid sharp bends, kinking, and excessive force. After placement, seal the deck penetration gland and tie the cables securely in place. The cable bracket must be installed on the mast to fix the relevant cables. The gooseneck must be installed on the side of the mast to protect the relevant cables against water.



WARNING: Ensure that cables have been run through watertight fittings to prevent water entry into the vessel when installation is completed.

1. Before placing the radome on the mast, the cables should route through the upper gooseneck from the under gooseneck labeled on the deck to facilitate connecting cables to the antenna as shown in the picture below.
2. Place sufficient cables (about 200mm past the edge of the mounting plate) to provide slack cable connections. Then, temporarily tie the cables to the cable bracket by using cable ties. After connecting the cables to the radome, tighten the cable ties to secure cables firmly.
3. Check the cables (RF-Tx/Rx cable, Power cable) are on the top of the mast.

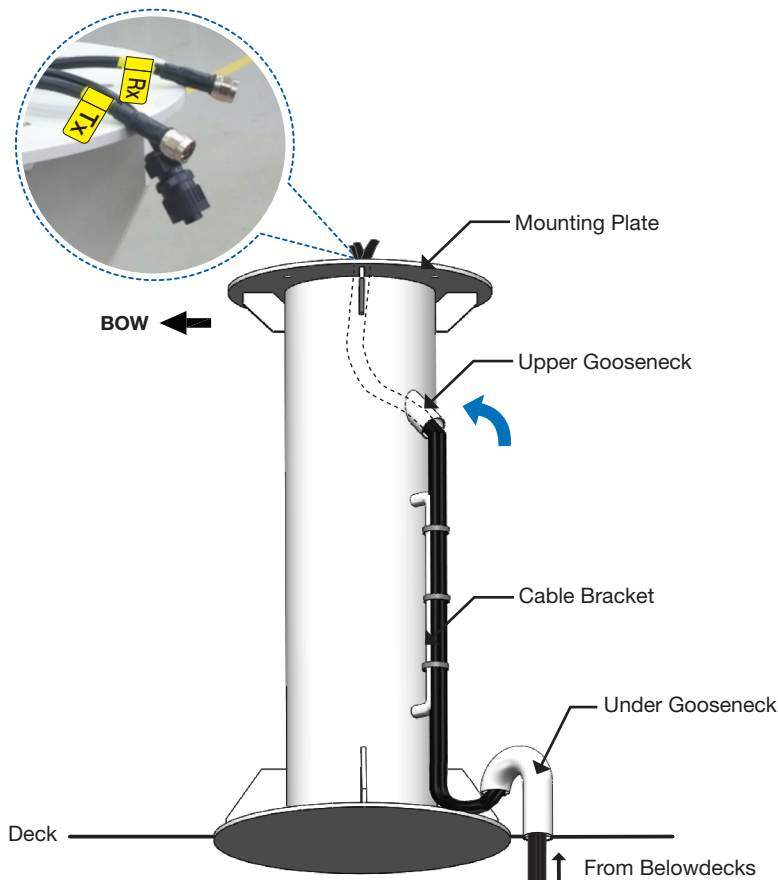

Power Connector Termination

Bring the 4 Pin Power Connector provided from the components box. To attach the supplied power connector to the end of your power cable, follow the steps below. The female connector mates with the male connector in the antenna.

1. Pass the end of the power cable through the connector's nut and housing as below.

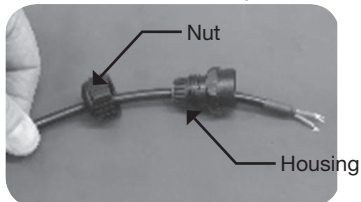

2. Strip the jacket from the end of the power cable 22mm. Then strip back the insulation of all three wires 8mm.

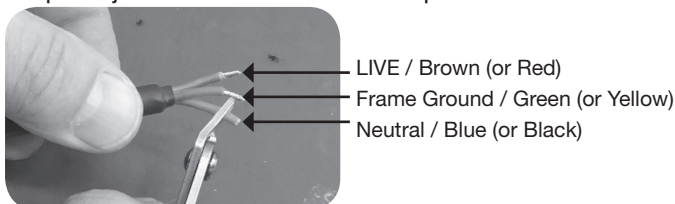

3. Connect the wires to the connector as below. Insert the wires to the supplied power connector by using a flat-head screwdriver. Refer to the pin-diagram below.

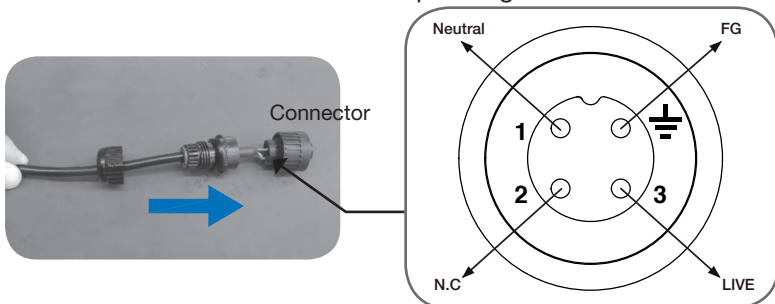

4. Slide the housing over the connector and tighten the nut onto the end of the housing. Confirm the completed power connector as below. Connect one end of the cable to the radome bottom and the other end to the ship's power.

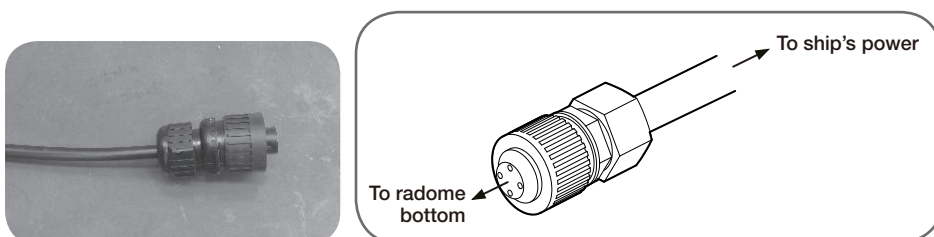

Antenna Installation

Unpacking Wooden Crate

The antenna pedestal is shipped completely assembled in its radome. The pallet should be lifted by means of a suitable sized lifting equipment.

Follow the procedures below.

Step 1.

1. Remove the 16 clips from the edge of the wooden crate by using a flat-head screwdriver.
2. After removing the fixing screw, lift up the top panel.

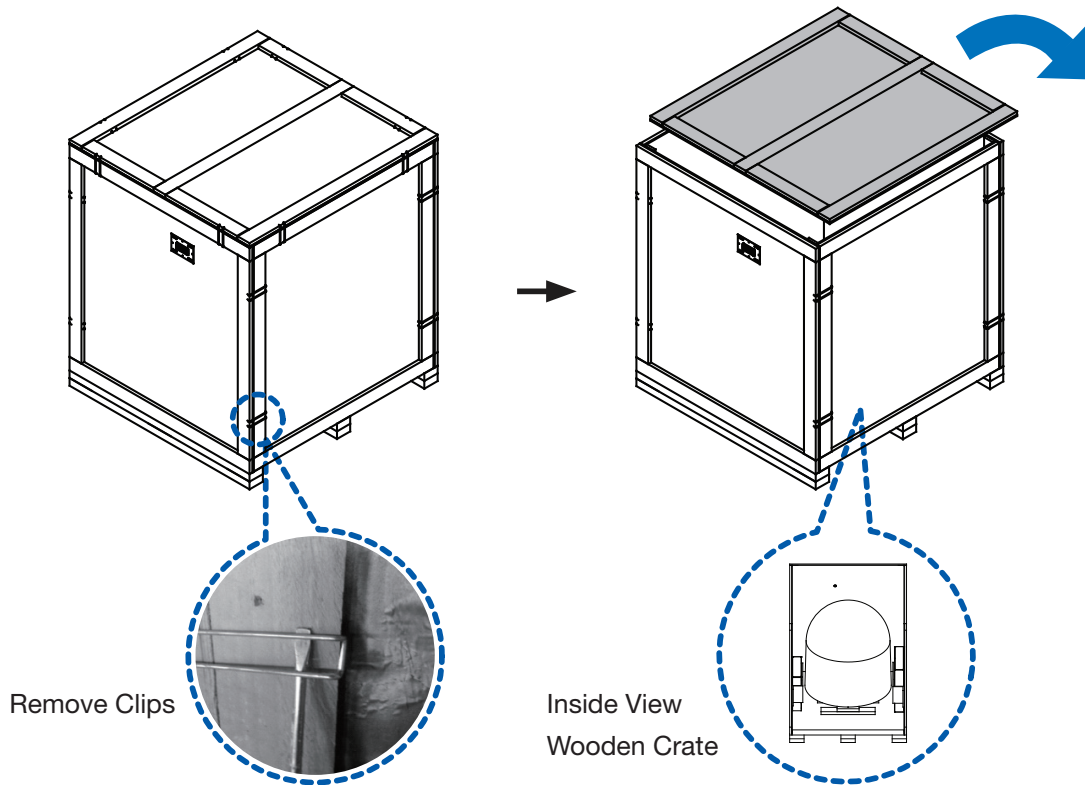

WARNING: Do not remove the side panel fixed with the fixing screw first. Otherwise, the wooden sticks fixed under the top panel may fall and damage the radome inside the wooden crate.

Step 2.

1. Take out the BDT box and the installation kit box from the wooden crate.

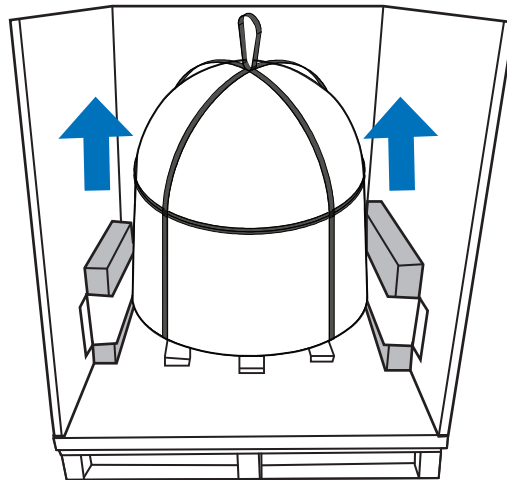

2. Remove the lifting strap by loosening the bolt in the shackle which connects the lifting straps on the bottom radome.

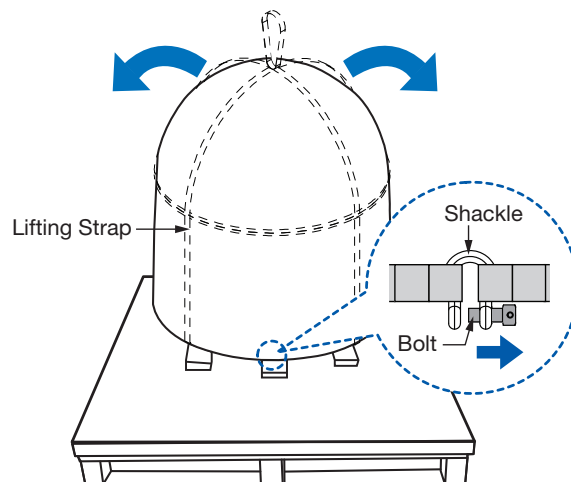
**Step 3.**

1. Loosen the bolts (6EA) on the bottom of the radome using a 5mm hex key. Unbolt the upper dome and keep the bolts save.
2. Gently lift and remove the upper dome and store it safely while removing shipping brackets.

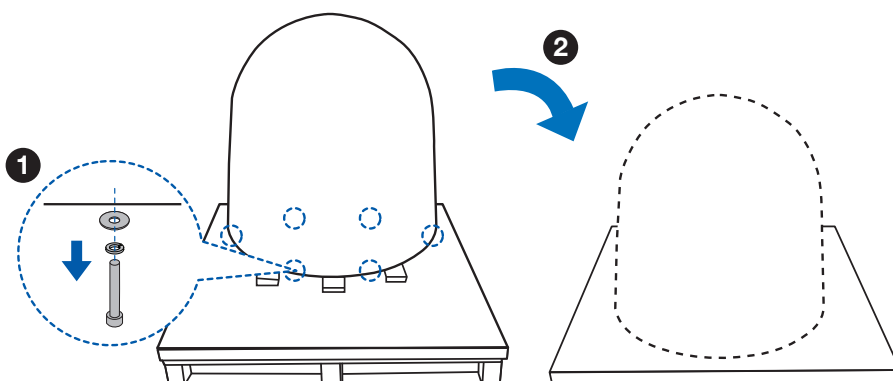

Step 4.

1. Remove shipping brackets securing the AZ axis and EL axis.

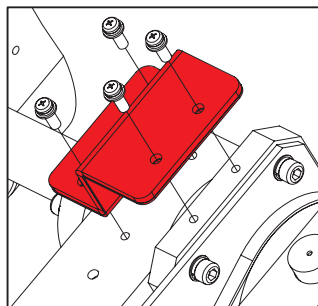
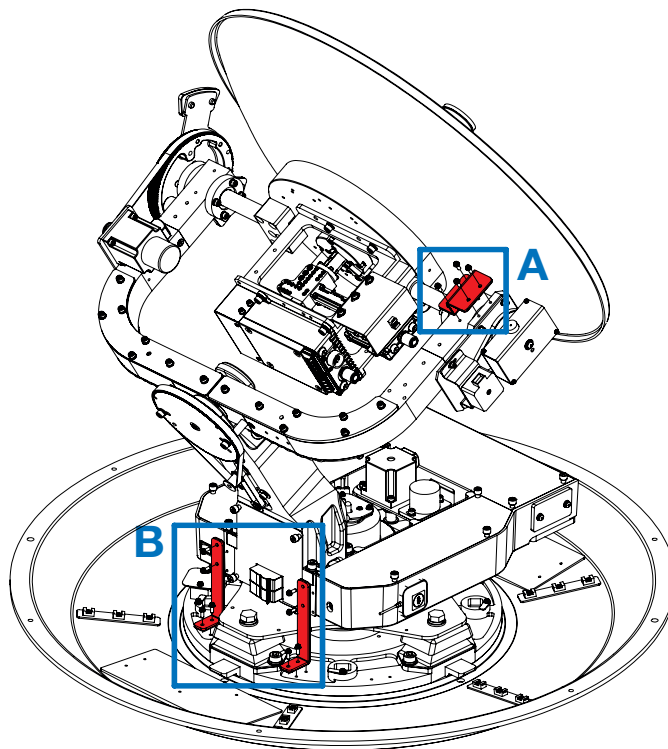

A. Remove the EL shipping bracket

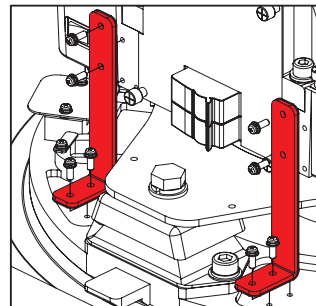

B. Remove the AZ shipping bracket

2. Remove shipping bracket securing the CL axis.

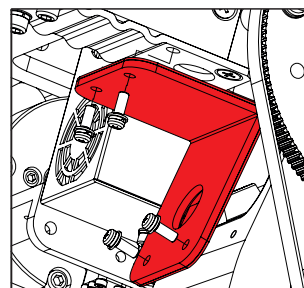
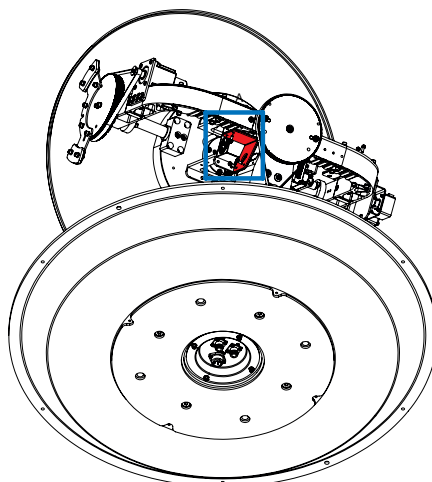

Remove the CL shipping bracket

Step 5.

1. Switch on "NORMAL" mode for operation.
2. Ensure that the power switch is "OFF" during the installation period.

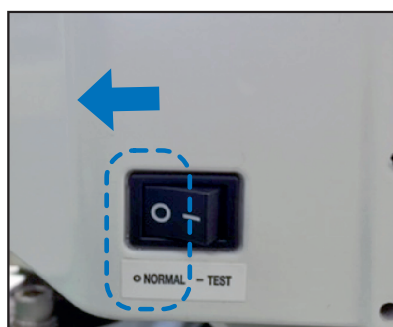
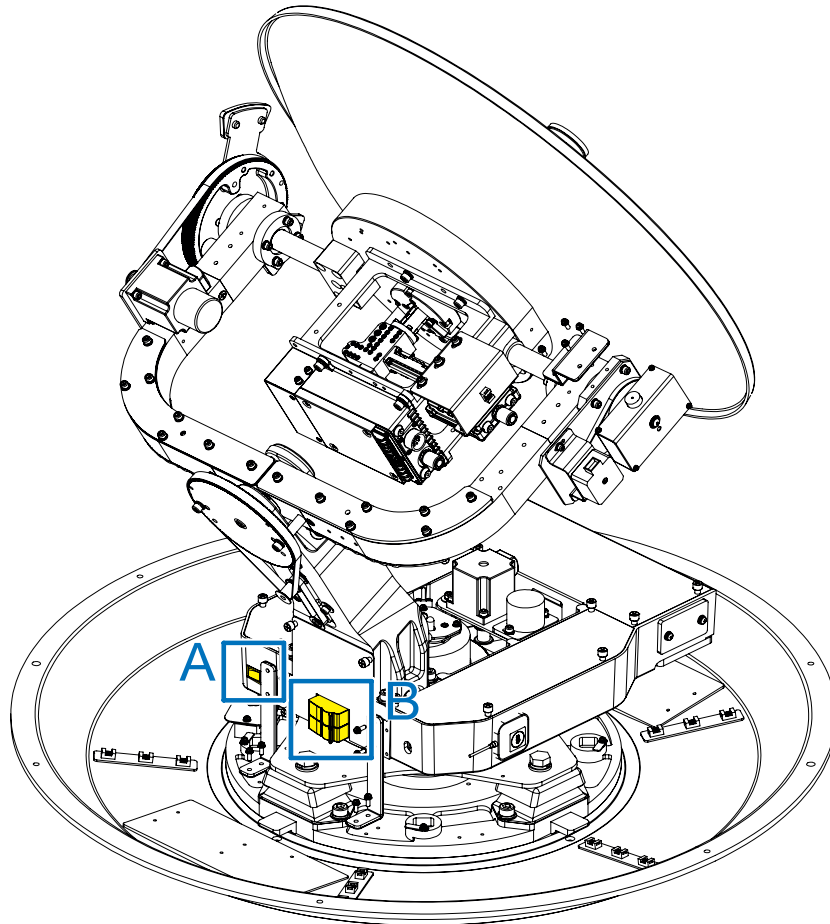
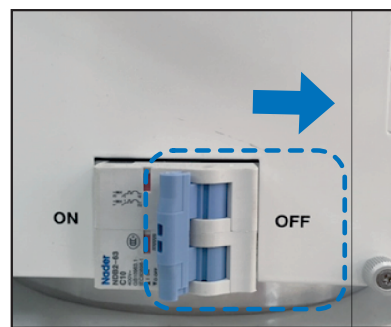
**A. Normal Mode****B. Turn Off Power Switch**

Step 6.

1. Re-assemble the upper radome and tighten bolts (6EA) on the bottom of the radome using a 5mm hex key. To ensure security, apply Loctite #242.

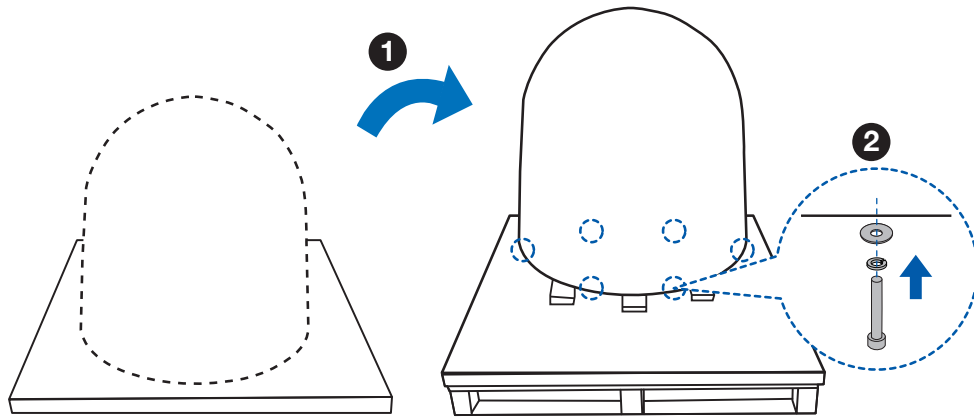

2. Secure the lifting straps by fastening the bolt in the shackle which connects the lifting strap on the bottom radome. Check on the condition of the lifting strap and make sure the shackle is tightened.

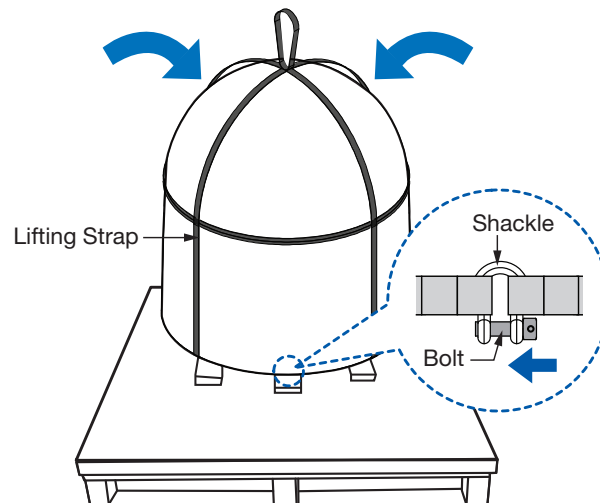

Step 7.

Using 19mm wrench, remove the nuts (4EA) and washers (4EA) that mount the antenna to the pallet.

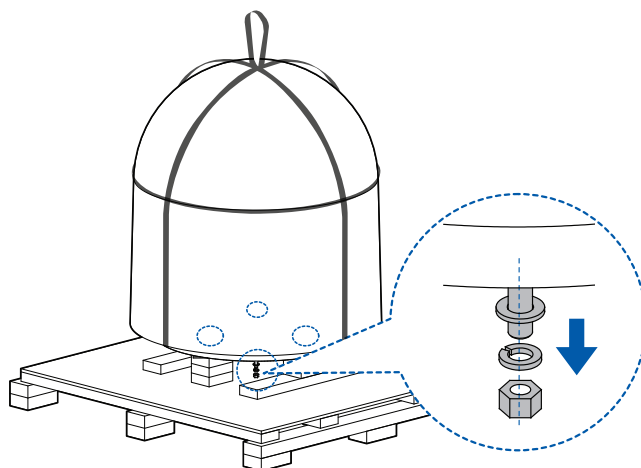
**WARNING**

WARNING: When lifting the antenna using the lifting straps, make sure to remove the securing nuts to separate antenna from the pallet.

Placing Antenna on Mast

The Intellian antenna comes with the lifting straps pre mounted from the factory. Before lifting, check the condition of the lifting strap and that the shackle is tightened up. Ensure the protection is on to avoid damaging the radome. Lift the antenna above the mast using the crane and maintain sufficient space(150mm) to perform cabling work.

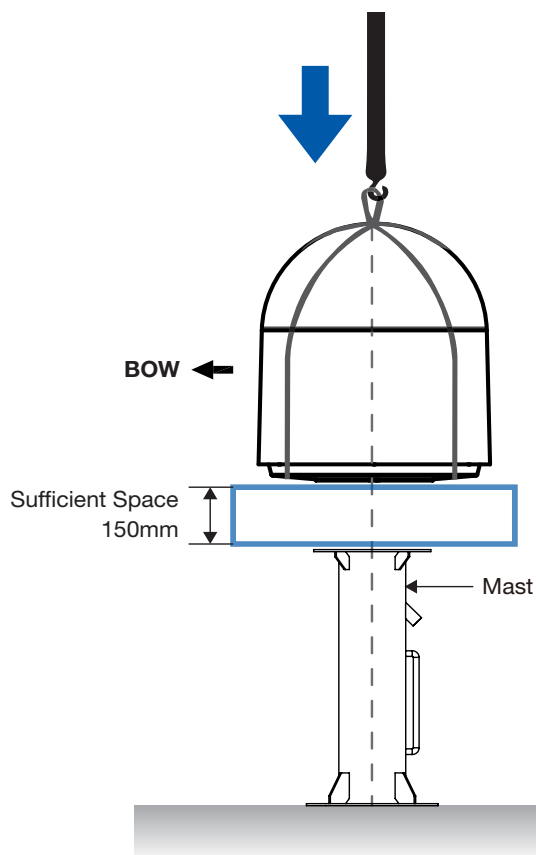

Connecting Cables (Customer Supplied)

Ensure that the power switch of antenna is off during the installation period.

Connect the two(2) RF cables to the antenna RF connectors and Power cable to the antenna power connector.

1. RF cables are labeled Tx and Rx for easy installation. Connect the “Tx” RF cable to the Tx connector and the “Rx” RF cable to the Rx connector as shown in the figure below. Ensure all cables are firmly fastened to the connectors. After connecting, slide the heat shrink sleeve onto the connector body and cable jacket then heat it to compress it into place using a hot air gun. Alternatively, use self-amalgamating tape and UV protective electrical tape.
2. Connect the Power cable to the power connector.

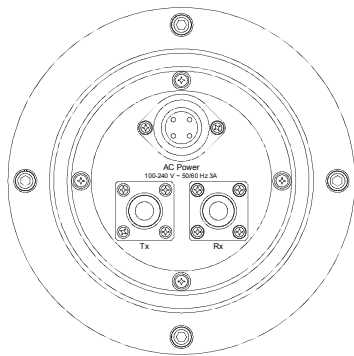
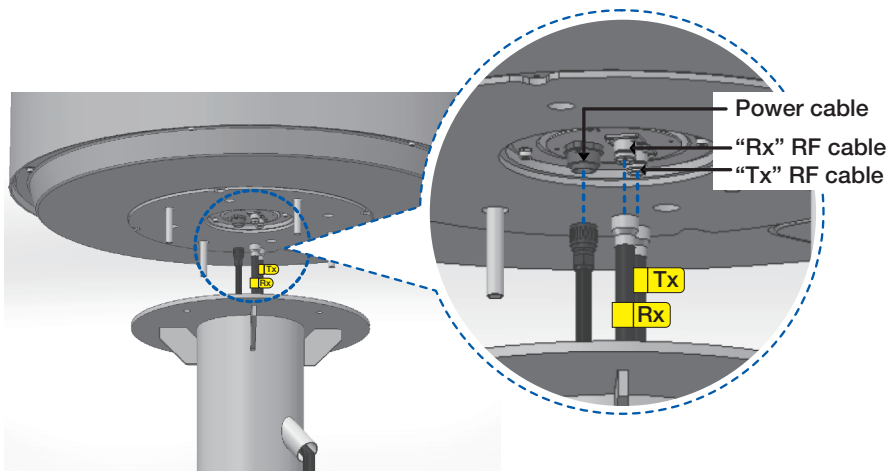

Radome Bottom View



CAUTION: Please ensure that the Tx and Rx cables are correctly connected to the each Tx/Rx connector on the antenna. Failure to connect the cables to the correct connector on the antenna will cause system damage.

Mounting Radome

1. Bolt the radome base directly to the support pedestal. Tighten the Washers/Nuts from bottom to top using the 19mm Spanner/Torque Wrench.

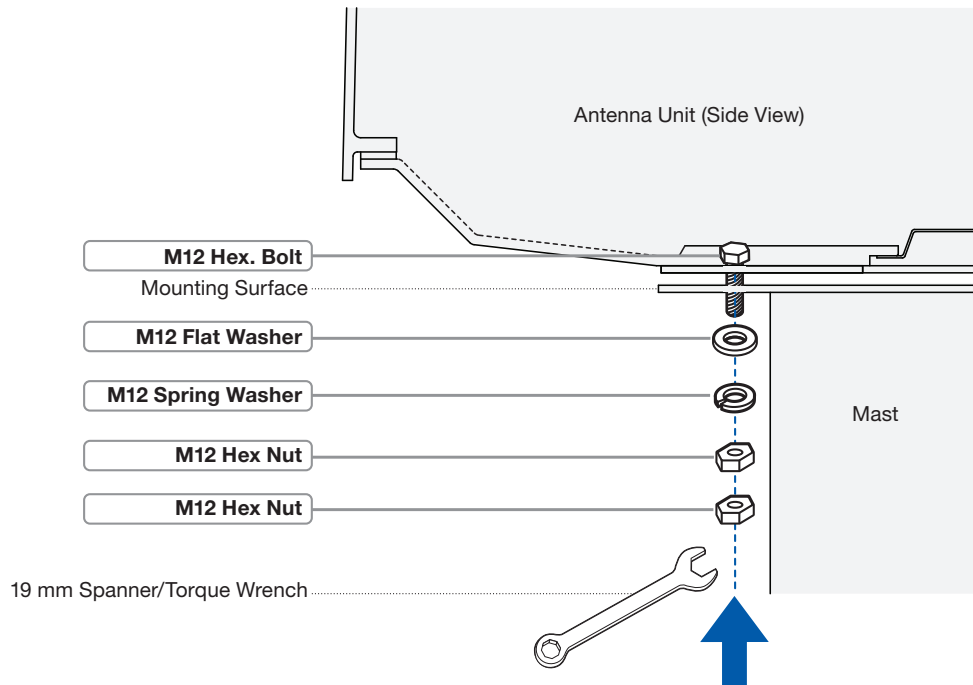

NOTE: Make sure when mounting the radome, use the shipping bolts on the radome's base. Bring the washers/nuts from the components box. Apply Loctite #262 or equivalent to the bolt thread, and fasten it to a torque setting of 110Nm.

2. Remove the lifting strap.

Turning on Power Switch

1. Bring the radome door key from the components box. Loosen the screws on the hatch by using the supplied door key and open the radome hatch.

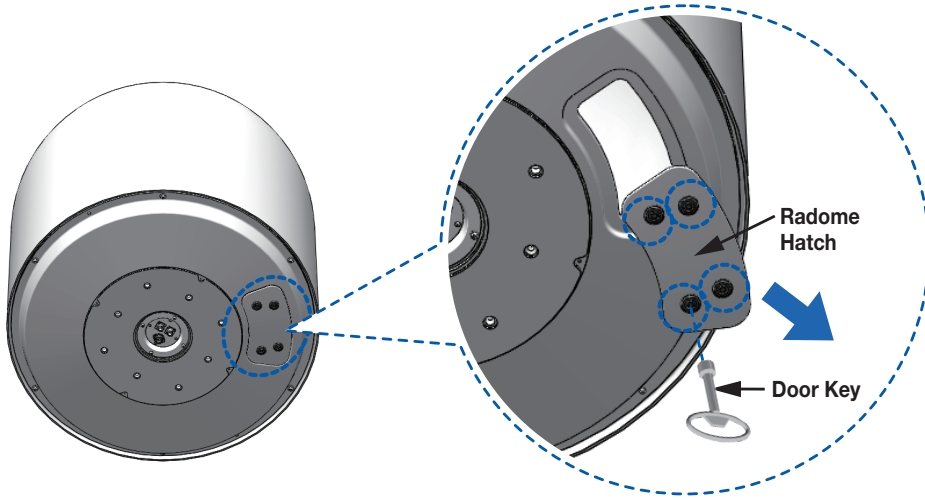

2. Turn On the power switch inside radome to activate the antenna.

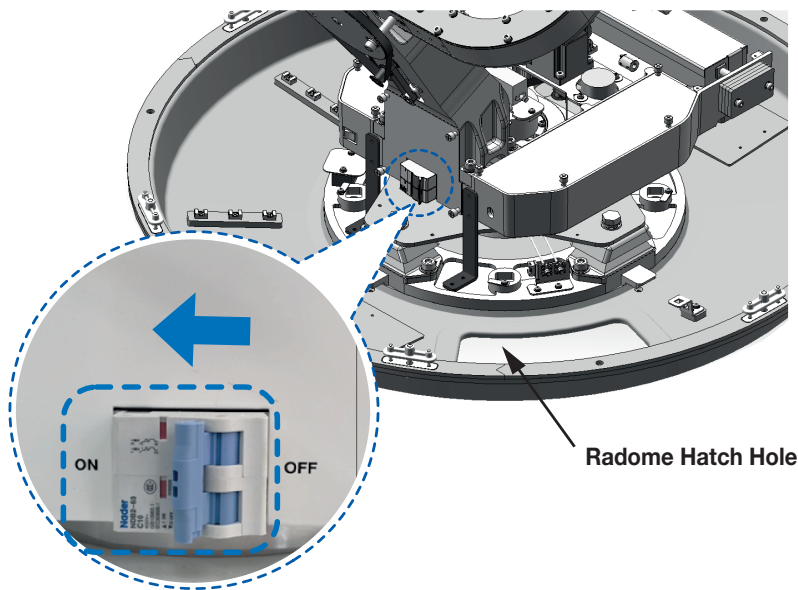

Turn on Power Switch



WARNING

WARNING: Ensure that all the hardware and cables have been installed, turn on the power switch.

3. After turning on the power switch, close the radome hatch and tighten the screws on the hatch by using the radome door key.

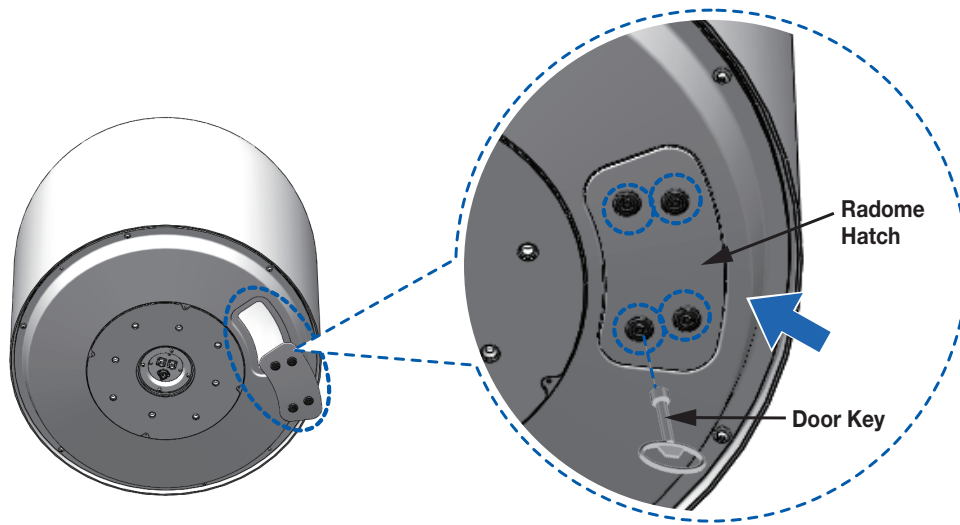

NOTE: After using the door key, store it in a safe place for future use.

Installing BDT

Mounting BDT

Intellian supplies two types of mounting methods 19" Rack Mount Type and Table Mount Type to mount the BDT.

19" Rack mount type

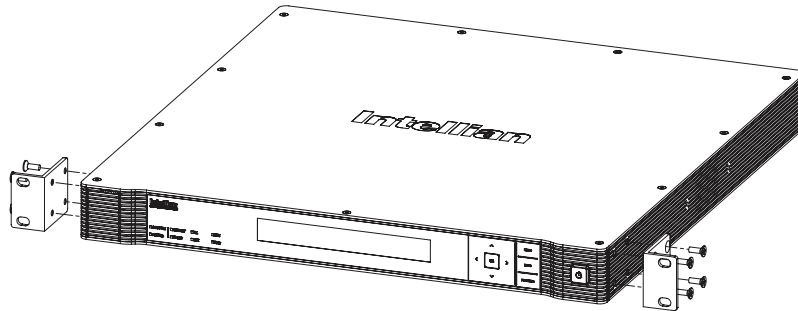

19" Rack Mount Type

- The BDT should be installed using the two supplied Rack Mounting Brackets which allow for a side 19" rack mounting configuration.
- Using the Flat Head Screw supplied, attach the mounting brackets to the sides of the BDT.
- Place the BDT on the 19" Rack.
- Connect the cables to the rear of the BDT.

Table mount type

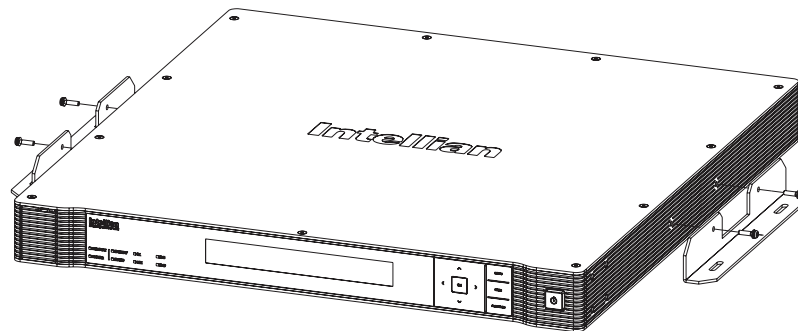

Table Mount Type

- The BDT should be installed using the two supplied Table Mounting Brackets which allow for a top or bottom mounting configuration.
- Using the Sems Bolt supplied, attach the mounting brackets to the sides of the BDT.
- Place the BDT in the location where it is going to be installed.
- Using a pencil to mark the 4 hole positions (2 each side), and use the appropriate drill bit to screw down the brackets.
- Connect the cables to the rear of the BDT.



WARNING

WARNING: Ensure that the cables connected to the BDT are long enough to prevent damage when the BDT is pulled out from the rack.

BDT Dimensions

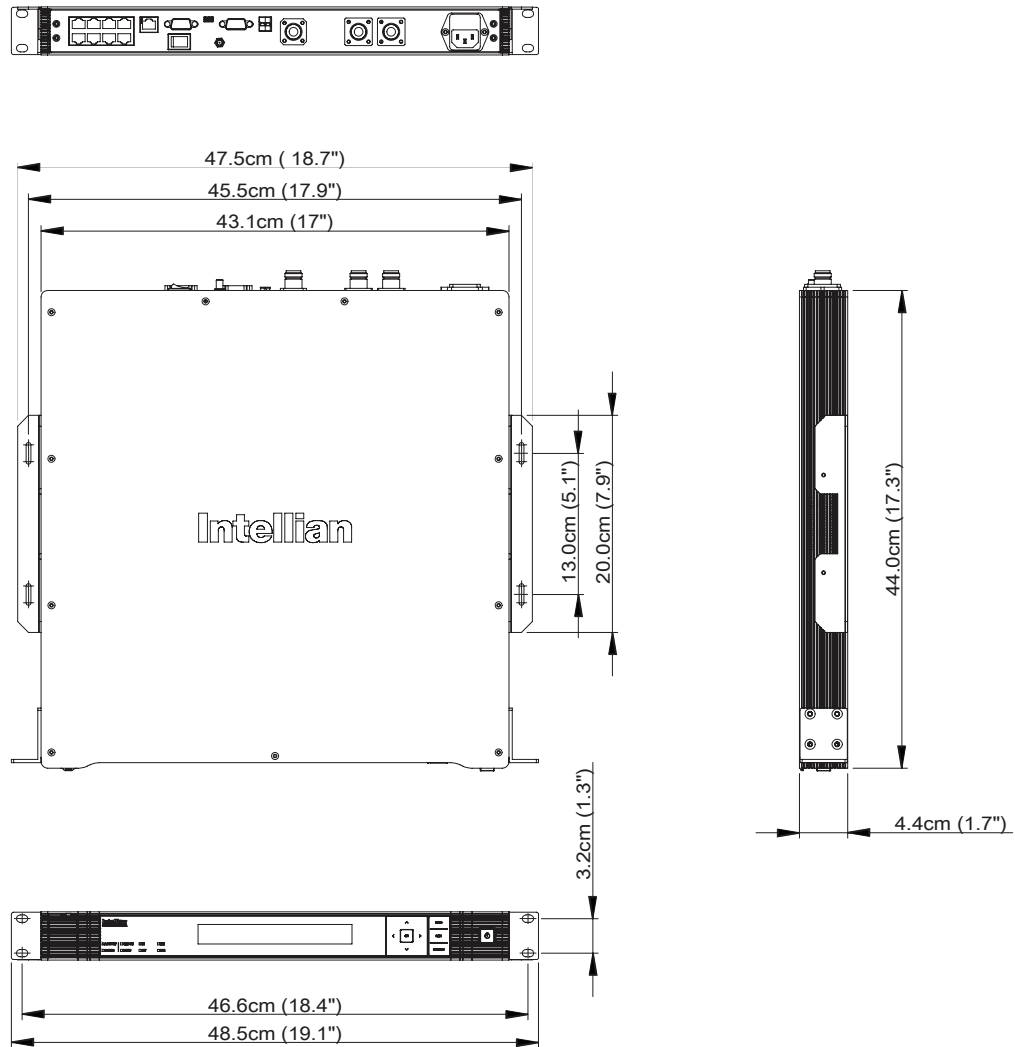

Selection of BDT Installation Site

The BDT should be installed below deck, in a location that is:

- Dry, cool, and ventilated.
- The front panel should be easy accessible to user.

Connecting Cables to BDT

RF Cable Connection

Connect the two(2) Antenna RF cables to the Antenna RF connectors on the rear of the BDT. Connect the Antenna "Tx" Cable to the "Antenna Tx" connector and the Antenna "Rx" Cable to "Antenna Rx" connector as shown in the figure below. Ensure all cables are firmly fastened to the connectors.



CAUTION: Please ensure that the Tx and Rx cables are correctly connected to the each Tx/Rx connector on the antenna. Failure to connect the cables to the correct connector on the BDT will cause system damage.



Ship Gyrocompass Connection

The ship's gyrocompass provides true heading input to the antenna allowing the antenna to target and acquire the desired satellite. Intellian always recommends connecting a ship's gyrocompass to the antenna using the gyrocompass interface on the BDT. If the ship's gyrocompass output is other than NMEA 0183 or NMEA 2000, the purchase of an NMEA converter may be required. THDs (Transmitting Heading Devices) that are approved for carriage on certain classifications of a vessel or a GPS compass with a compatible NMEA output and heading sentence can be also used.

Recommended Cable

- NMEA 0183 Gyrocompass Interface Cable (Customer supplied)
- Connector Type: 2 conductors for NMEA 0183, Mini-C 5 pin for NMEA 2000
- NMEA heading sentence: xx HDT (4800 Baud, 8, N,1) If there is no HDT sentence then use HDM sentence instead.
- NMEA 2000 heading PGN Number = 127250 (Vessel Heading)

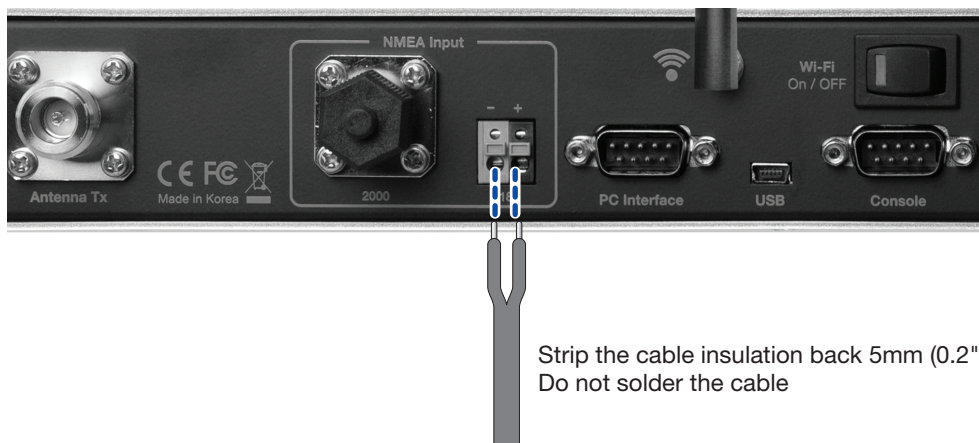

PC to BDT Communication Setup

You can establish data communication between a PC and the BDT using one of the following methods.

TCP/IP Connection

Connection through Front Panel Management LAN Port

To connect the BDT to the PC through the Management LAN Port on the front BDT panel, the network should be configured by setting up the PC IP before the connection. This method requires separate IP configuration on a PC.

1. Connect an Ethernet cable from a PC Ethernet port to the Management Port on the front of the BDT.
2. Go to Control Panel > Network and Sharing Center > Change Adapter Settings. Right-click on the Local Area Connection and click Properties.
3. Select TCP/ IPv4, and click Properties.
4. Change the network settings on a PC. **(Example)**
 - **IP: 192.168.1.11** (Do not use 192.168.1.1~10, which are only for internal use.)
 - **Subnet Mask: 255.255.255.0**
5. Use the following IP address to access Intellian Aptus or Aptus Web page.
 - **Default IP: 192.168.1.2**

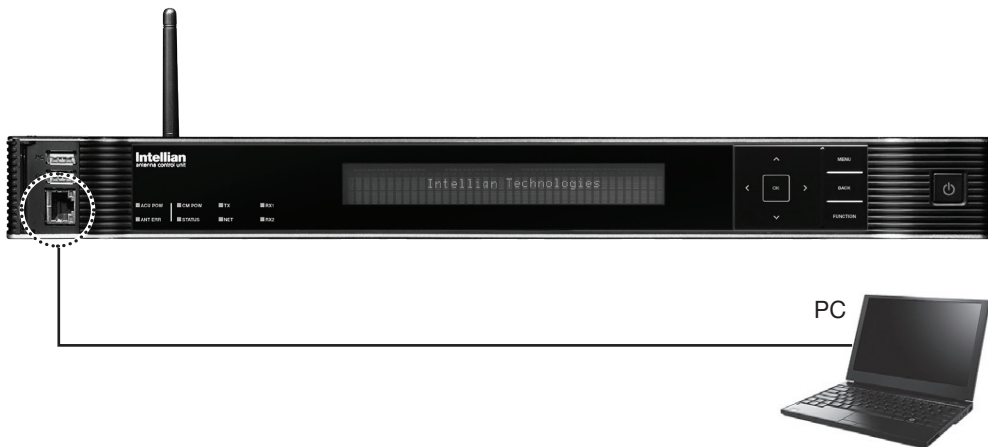

Wi-Fi Connection

You can connect to the BDT via Wi-Fi for easy management and control whenever you are on the vessel.

1. Turn on the Wi-Fi power switch located on the rear of the BDT. After 30 seconds, confirm that a red light appears on the switch.
2. Use the following IP address to access Intellian Aptus or Aptus Web page.
 - **Default IP: 192.168.1.2**



Checking Modem Information

After installation is complete, terminal activation requires a Provisioning Key and Terminal ID of the iDirect modem. Intellian provides this information in the form of package labels as well as displaying on the Aptus software.

- Provisioning Key and Terminal ID Label

PIK: XXXXXXXXXX==
TID: TID: INT-MAR-SCM-XXXXXXX

NOTE: The PIK and TID information depends on the serial of the integrated modem and GX antenna model.

- Label positions

① BDT top cover

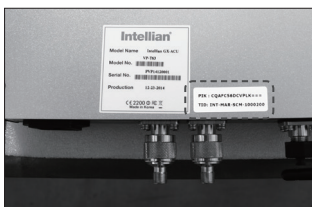

② BDT package box

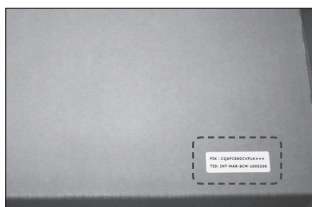

③ User manual package

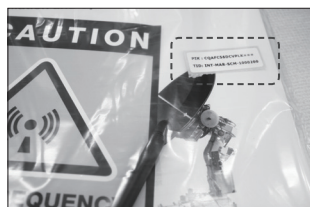

④ Aptus software display

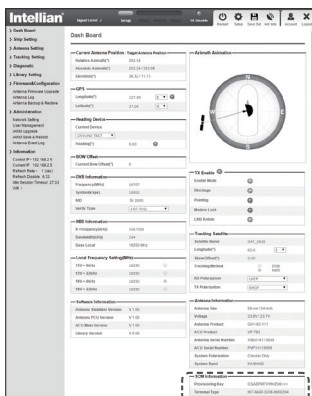

One-touch Commissioning

Ensure to perform One-touch Commissioning after the first-time connection of the GX terminal and the BDT, after cable replacement or Ku-to-Ka conversion. Take the following steps for One-touch Commissioning.

1. Connect an Ethernet cable from a PC Ethernet port to the Front Ethernet Port of the BDT. (See PC to BDT Communication Setup section for details.)
2. Open a web browser on the PC and type the default IP address (192.168.1.1) to access the iDirect modem's web page.
3. Login to the iDirect modem page using ID: **admin**, PW: **iDirect123!** (or P@55w0rd!).
4. Click “Commissioning” > “One Touch Commissioning”
5. Click “Start” button and monitor the progress on the web page.

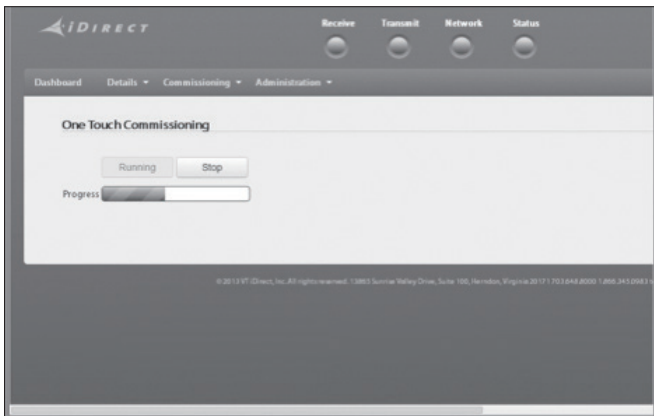

6. Check that Commissioning is complete and “BUC Calibration done!” message is displayed.

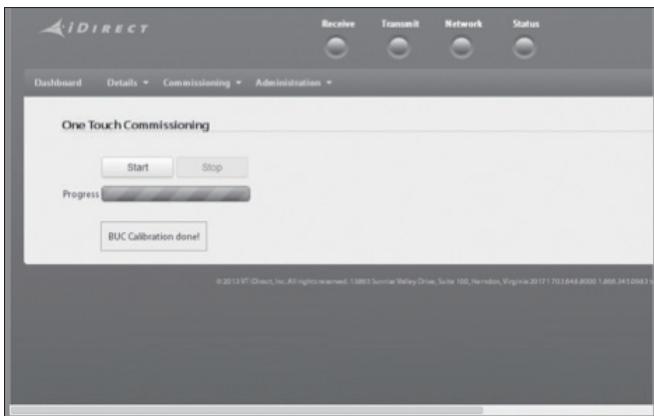

BDT Connector Guide

• Console port

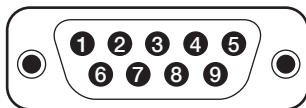

BDT console port:
D-sub 9 pin male

Pin	Signal
1	NC
2	Console RX(RS-232)
3	Console TX(RS-232)
4	NC
5	GND

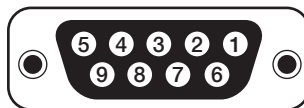

Supplied component:
D-sub 9 pin female

Pin	Signal
6	NC
7	NC
8	NC
9	NC

Note: Use Cross Serial Cable for PC Interface. (Intellian supplied)

• PC Interface

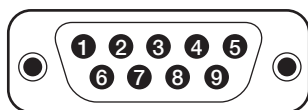

BDT PC Interface port:
D-sub 9 pin male

Pin	Signal
1	GPS IN+(Spare)
2	PC RX(RS-232)
3	PC TX(RS-232)
4	NC
5	GND

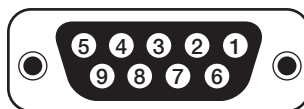

Supplied component:
D-sub 9 pin female

Pin	Signal
6	GPS IN-(Spare)
7	NC
8	NC
9	NC

Note: Use Cross Serial Cable for PC Interface. (Intellian supplied)

• NMEA 2000

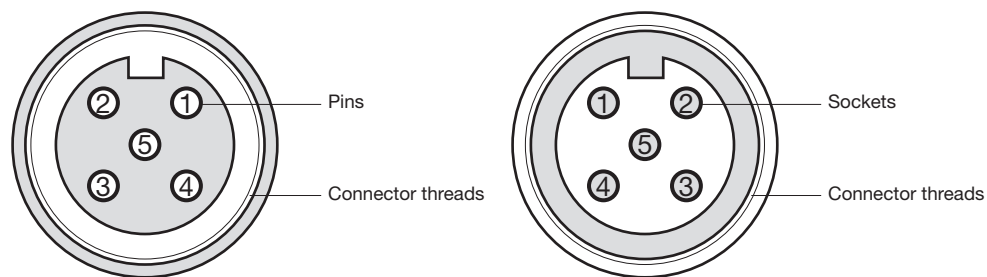

BDT NMEA 2000 port :
male

Supplied component:
female

Pin	Signal
1	Shield
2	NET-S, (Power supply positive, +V)
3	NET-C, (Power supply common, -V)
4	NET-H, (CAN-H)
5	NET-L, (CAN-L)

• LAN

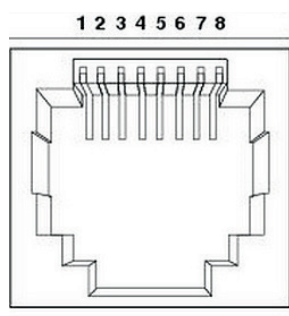

BDT LAN port

Pin	Signal	Pin	Signal
1	TX+	6	RX-
2	TX-	7	NC
3	RX+	8	NC
4	NC		
5	NC		

Operating BDT

Introduction

This section of the handbook describes how to setup your system after installing the BDT.

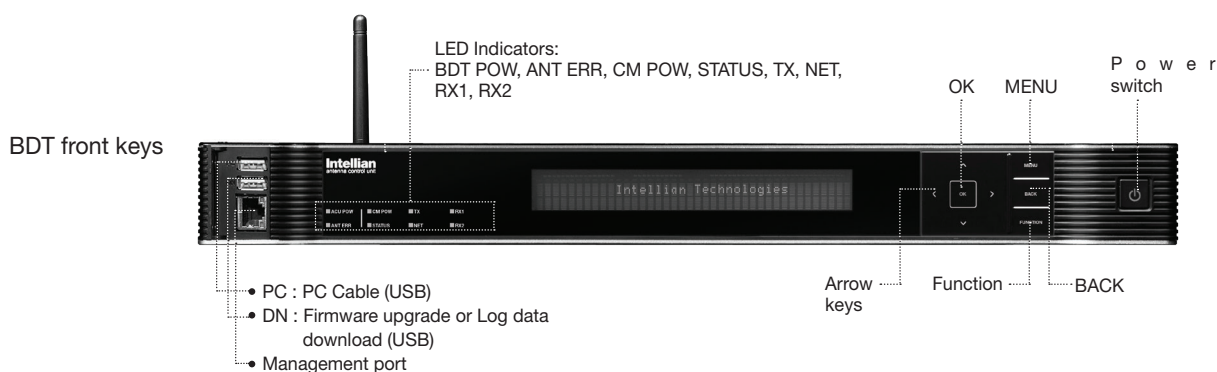

Touch key functions

Touch key	Function
MENU	Enter SETUP mode
BACK	In SETUP mode, returns to previous menu or option or saves the adjusted settings. In Normal mode, returns to the first page of antenna current status.
FUNCTION	Saves the adjusted settings.
Arrow keys	Selects from the alternative options to increase or decrease the selected character to a desired value.
OK	Enter next step / menu

Normal Mode

Startup

With the system installed and power applied, the BDT screen will show the following sequence.

Start up

```
INTELLIAN TECHNOLOGIES INC.
```

1. The data communication is being established between the antenna and the BDT.

Initialize antenna info

```
INITIALIZE - ANTENNA INFO  
INTELLIAN GX60
```

2. The BDT receives antenna information.

Initialize elevation &
Cross level angle

```
INITIALIZE - EL POSITION  
INTELLIAN GX60
```

3. The elevation angle and cross level angle are initialized.

Initialize azimuth angle

```
INITIALIZE - AZIMUTH POSITION  
INTELLIAN GX60
```

4. The azimuth angle is initialized.

Initialize target satellite
position

```
INITIALIZE - SAT POSITION  
INTELLIAN GX60
```

5. The antenna returns to the target satellite position.

Search status

```
SEARCH1 062.6E I5_F1 SIG: 102  
AZ: 254.3( 164.3) EL: 10.9
```

6. The antenna is searching for the target satellite.

Tracking status

```
TRACKING 062.6E I5_F1 SIG: 201#  
AZ: 254.3( 164.3) EL: 10.9 Fn
```

7. The antenna has locked onto the satellite.

Monitoring Current Antenna Status

When the BDT power is on, it displays the status of the antenna. The current status of the antenna is displayed as shown below.

Current search status

```

+ SEARCH1 062.6E I5_F1 SIG: 102 +
AZ: 254.3 ( 164.3) EL: 10.9
    
```

1. The antenna is searching for the target satellite.

Current tracking status

```

+ TRACKING 062.6E I5_F1 SIG: 201# +
AZ: 254.3 ( 164.3) EL: 10.9 Fn
    
```

2. The antenna has locked onto the target satellite.

Current IF signal level SIG/ AGC is displayed. SIG will be displayed when NBD (Narrow band detection) mode for TRACKING SIGNAL is chosen to be used and AGC will be displayed when DVB mode of TRACKING SIGNAL is chosen to be used.

The symbol "•" will be only displayed when the satellite signal is strong enough to locked onto.

True azimuth [254.3] position of the antenna is the sum of ships heading 090.0 [HDG] and antenna relative [164.3].

NOTE: However, if the "GYRO TYPE" is set to "NONE" or "NMEA" but without receiving a proper input signal, "---." will be displayed at "True Azimuth"

Save current satellite info

```

SAVE CURRENT SAT INFO ?
+ YES NO
    
```

3. Touch FUNCTION key to save current satellite information or abort and return to the main display. "Fn" will be displayed only if the antenna is in tracking mode.

Current tracking status

```

# TRACKING 062.6E I5_F1 SIG: 201#
AZ: 254.3 ( 164.3) EL: 10.9 Fn
    
```

4. Touch RIGHT arrow key to display NBD, GPS and ship's heading information.

Tracking & Heading information

```

# NBD F: 1457000 BW: 1440 SIG: 201#
127.04E 37.06N HDG: 090.0 L: 18250 Fn
    
```

5. NBD, GPS and ship's heading information are shown.

- NBD (Narrow Band Detection) IF tracking frequency: 1457000 KHz
- Detected Band Width: 1440KHz
- SIG (Signal Level): 201
- W (West)/E (East) Longitude: 127.04 ° E
- N (North)/S (South) Latitude: 37.06° N
- HDG (Ship's Heading): 090.0 degree
- LNB local oscillator (LO) frequency: 18250 MHz

Antenna & BDT versions

```

# GX1-62-111 ANT SERIAL 1.00/1.00#
VP-T63 ACU SERIAL 1.00
    
```

7. Touch RIGHT arrow key to display the below information.

- Antenna part number, antenna serial number and PCU and Stabilizer firmware version.
- BDT part number, BDT serial number, BDT firmware version.

Touch BACK Key to return to the first page of the antenna current status.

Select USB functions

```

# [USB FUNCTION] SELECT USB FUNCTION#
UPGRADE FIRMWARE
    
```

8.Touch RIGHT arrow key to display the **USB FUNCTION***

This menu will be displayed automatically if a USB flash drive is plugged into the USB port located in the front panel of the BDT.

USB FUNCTION*

- UPGRADE FIRMWARE: upgrade the system by using the firmware files (files format: *.FWP) from the specified folder in the USB flash drive.
- COPY LOG DATA: Copy the up-to-date log data from the system to the USB flash drive.



Upgrade
the
system

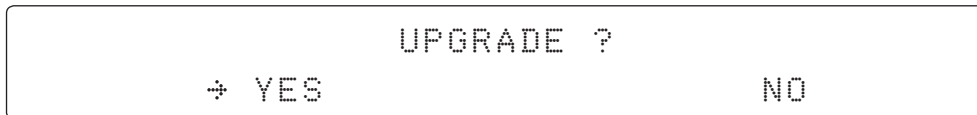

9. Touch OK key to upgrade firmware.

Refer to the error messages below if any errors occur.

UPGRADE FIRMWARE

- FIRMWARE FILE NOT FOUND: the system cannot find the FWP file.
- INVALID FIRMWARE: the file is not in a recognizable FWP format.
- MORE THAN 1 FILE EXIST: there is more than 1 firmware file that exists from the specified folder in the USB flash drive.
- CHECK USB CONNECTION: the USB flash drive is not connected.

COPY LOG DATA

- COPY LOG DATA TO USB [30%]: display the copy progress in percentages.
- NOT ENOUGH SPACE IN USB: USB occupies no memory space.
- CHECK USB CONNECTION: the USB flash drive is not connected.

Real-time
diagnostic
result

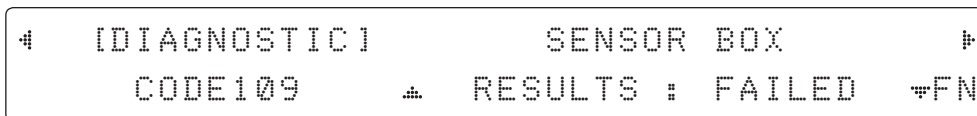

10. Touch RIGHT arrow key to display the real-time diagnostic result.

The real-time diagnostic code will be displayed automatically if there is any error found during the system operation. However, this page will not be displayed if there is no error message.

Erase
error message

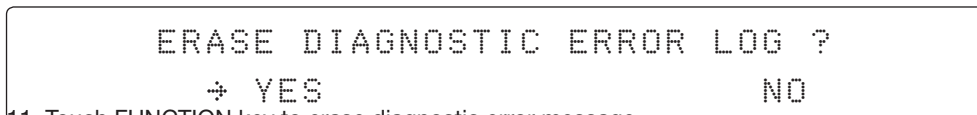

11. Touch FUNCTION key to erase diagnostic error message.

Setup Mode

Enter the SETUP mode. Simply follow the instructions below.

Searching / Tracking mode



1. While the antenna is in SEARCHING/TRACKING mode, touch MENU key to enter SETUP mode. * indicates the key pad lock function is on (Refer to KEY LOCK menu to setup the key pad lock function). When key pad lock function is activated touch MENU key or when “Fn” menu is activated touch FUNCTION key then ENTER PASSWORD menu will be displayed.

Setup mode

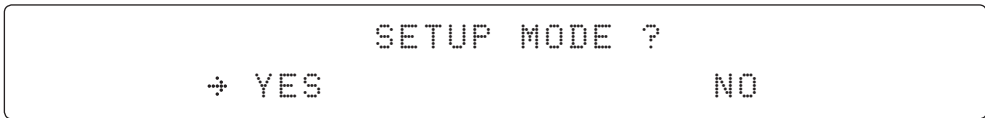

2. Touch LEFT arrow key to move cursor to YES and touch OK key to enter SETUP mode or touch RIGHT arrow key to move cursor to NO and touch OK key to abort and return to the main display.

Exit setup mode

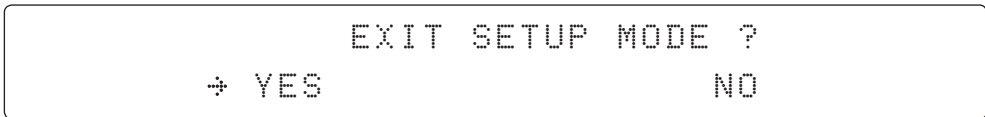

3. While the antenna is in SETUP mode, touch FUNCTION key as shortcut key to exit SETUP mode.

Antenna Settings

Manual Search

Search the desired satellite manually.

Setup mode

```

                SETUP MODE ?
          ↵ YES                               NO
    
```

1. Touch LEFT arrow key to move cursor to YES and touch OK key to enter SETUP mode.

Antenna menu

```

    ↵↵ANTENNA                               ↵SATELLITE
      ↵SYSTEM
    
```

2. Touch OK key to enter ANTENNA menu.

Manual search menu

```

    ↵↵MANUAL SEARCH                         ↵DIAGNOSTIC
    
```

3. Touch OK key to enter MANUAL SEARCH menu.

Antenna movement

```

STEP SIZE  AZIMUTH  ELEVATION  AGC
# 00.2 #  ↵ 231.7 ▶  ↵ 48.3 ▼  301 Fn
    
```

4. Current IF tracking signal level (AGC)/(SIG/dB scale) is displayed to assist you in manually peaking AZIMUTH (0°-360°) and ELEVATION (0°-90°) angle for best signal level.

Touch NUMBER key to change the STEP SIZE (Range: 0.1~99.9). Touch LEFT and RIGHT arrow keys to increase or decrease the azimuth angles. Touch UP and DOWN arrow keys to increase or decrease the elevation angles.

Touch FUNCTION key to save current settings or abort and return to the main display.

Save

```

                SAVE CURRENT SAT INFO?
          ↵ YES                               NO
    
```

5. If the current settings are able to locate the satellite, touch FUNCTION key to save “current satellite information”. This will help to reduce the satellite acquisition time after restarting the system. Touch LEFT arrow key to move cursor to YES and touch the OK key to save the settings.

NOTE: If the gyrocompass type is not NMEA or the gyrocompass is not connected to the BDT, the information cannot be saved.

Antenna Diagnostic Test

Refer to the diagnosis codes for the test results.

Setup mode

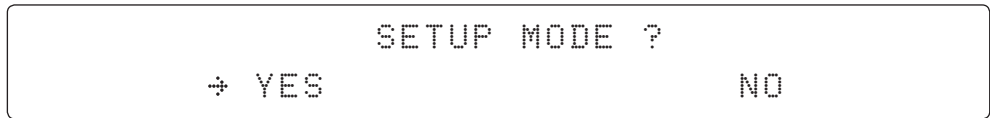

1. Touch LEFT arrow key to move cursor to YES and touch OK key to enter SETUP mode.

Antenna menu



2. Touch OK key to enter ANTENNA menu.

Diagnostic menu

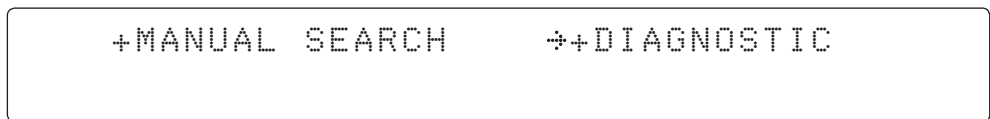

3. Touch arrow keys to move cursor to DIAGNOSTIC menu and touch OK key to enter it.

Full diagnostic test

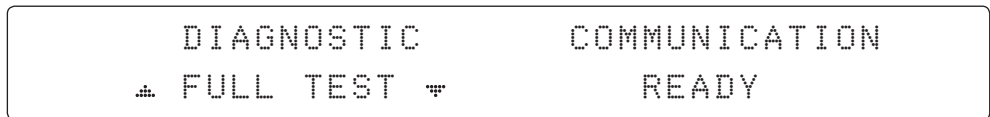

4. Touch UP and DOWN arrow keys to select a full diagnostic test or single diagnostic test and touch OK key to execute the selected diagnostic test.

Menus for DIAGNOSTIC are FULL TEST and CODE 101 ~ CODE 116.

Full diagnostic test result



5. A full diagnostic is successfully completed.

Single diagnostic test result

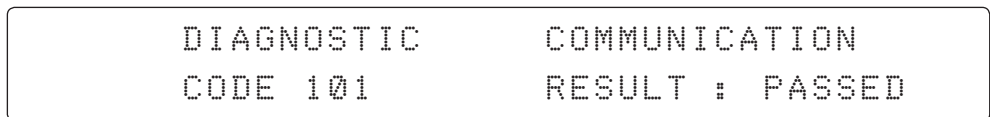

6. A single diagnostic test is successfully completed.

Diagnosis Code:

- CODE 101: The data communication between the antenna and the BDT is tested.
- CODE 102: The azimuth motor is tested.
- CODE 103: The elevation motor is tested.
- CODE 104: The cross-level motor is tested.
- CODE 105: The azimuth encoder is tested.
- CODE 106: The cross-level encoder is tested.
- CODE 107: The rate sensor is tested.
- CODE 108: The tilt sensor is tested.
- CODE 109: The sensor box motor is tested.
- CODE 110: The LNB/NBD is tested.
- CODE 111: The LNB pol motor is tested.
- CODE 112: The sub-reflector is tested. (Skip for v-Series communication products)
- CODE 113: The antenna power is tested.
- CODE 114: The BDT power is tested.
- CODE 115: The receiver power is tested. (Skip for v-Series communication products)
- CODE 116: The home sensor is tested.

An example of test result after a full test: ●2●●●●●●●●●●-●●-●

- : test is passed
- 2: test is failed (CODE102)
- : test is skipped (TVRO products only)
- ?: test is in process

Satellite Settings

Load Satellite

Setup mode

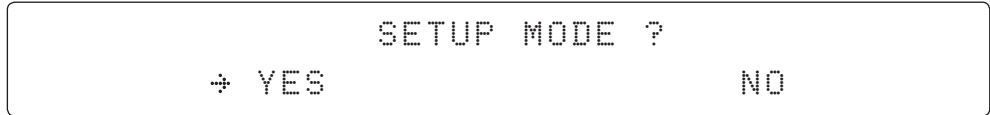

1. Touch LEFT arrow key to move cursor to YES and touch OK key to enter SETUP mode.

Satellite menu

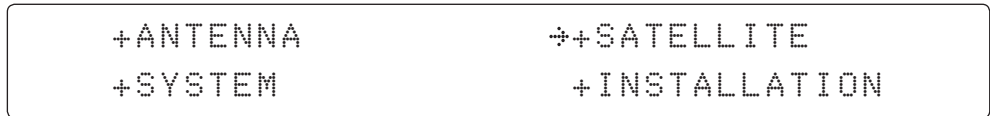

2. Touch RIGHT arrow key to move cursor to SATELLITE and touch OK key to enter it.

Load sat menu



3. Touch OK key to enter LOAD SAT. menu.

Load satellite

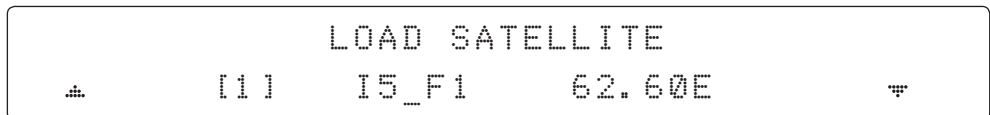

4. Touch UP and DOWN arrow keys to select satellite that you wish to track. Touch OK key to load the selected satellite.

Load

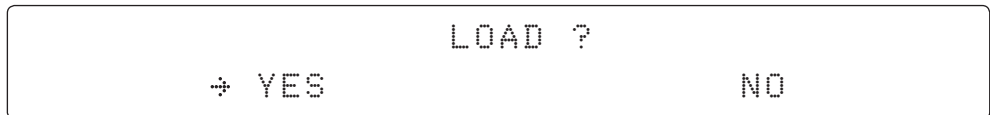

5. Touch LEFT arrow key to move cursor to YES and touch OK key to load the selected satellite and execute the current settings. Or touch RIGHT arrow key to move cursor to NO and touch OK key to abort and return to the main display.

System Settings

Set Location

Setup mode

SETUP MODE ?
 → YES NO

1. Touch LEFT arrow key to move cursor to YES and touch OK key to enter SETUP mode.

System menu

+ANTENNA +SATELLITE
 →+SYSTEM +INSTALLATION

2. Touch DOWN arrow key to move cursor to SYSTEM and touch OK key to enter it.

Set location menu

→+SET LOCATION +MANAGEMENT
 +KEY LOCK

3. Touch RIGHT arrow key to move cursor to SET LOCATION and touch OK key to enter it.

Gyro type and Baud rate

GYRO TYPE BAUD RATE
 NMEA ▲ 4800 ▼

4. Set the ship's **GYRO TYPE*** and **BAUD RATE**.

A search pattern 1 or 3 will be initiated according to which gyrocompass type is selected and the existence of the gyrocompass input. Set the BAUD RATE as 4800, 9600, 19200 or 38400 according to your device.

A search pattern 1 will be initiated automatically if the gyrocompass input does not exist and the gyrocompass type is selected other than GROUND TEST.

NOTE: The bow offset will not be saved automatically if Search 1 pattern is initiated. In this case, the antenna will need to re target the desired satellite using Search 1 every time if the antenna restarts.

Gyro search type

Setting of Heading Device			
Existence of Heading Data	No Device	NMEA / NMEA 2000	Ground Test
With Heading Data	Search 1	Search 3	Search 3
Without Heading Data	Search 1	Search 1	Search 3

- GYRO TYPE***
 NO DEVICE
 NMEA
 NMEA 2000
 GROUND TEST

Latitude & longitude

←	→	LATITUDE	LONGITUDE	→
		37.00N	126.50E	

5. Set the current LATITUDE and LONGITUDE
Touch LEFT and RIGHT arrow keys until the desired character is underscored (selected).
Touch UP and DOWN arrow keys to increase or decrease the value, or touch NUMBER keys to set the desired value directly.
Touch the OK key to set the parameter.

Heading

←	HEADING	→
	090.0	

6. Entry of ship's heading is not required when your system is connected to a NMEA(0813) or NMEA2000 Heading Gyrocompass output.
Ensure that the supported gyrocompass type is set correctly. If the ship's gyrocompass output is other than NMEA and Synchro, a purchase of an NMEA converter is required.

Save

	SAVE ?	
→	YES	NO

7. Touch LEFT arrow key to move cursor to YES and touch OK key to save current settings, or move cursor to NO and touch OK key to abort and return to the main display.

Management

Setup mode

```

                SETUP MODE ?
          ↗ YES                NO
    
```

1. Touch LEFT arrow key to move cursor to YES and touch OK key to enter SETUP mode.

System menu

```

    +ANTENNA                +SATELLITE
    ↗+SYSTEM                +INSTALLATION
    
```

2. Touch DOWN arrow key to move cursor to SYSTEM menu and touch OK key to enter it.

Backup and restore menu

```

    +SET LOCATION          ↗+MANAGEMENT
    
```

3. Touch arrow keys to move cursor to MANAGEMENT menu and touch OK key to enter it.

Select process type

```

                SELECT PROCESS TYPE
          ⬆          BACKUP USER DATA          ⬇
    
```

4. Touch UP and DOWN arrow keys to **SELECT PROCESS TYPE***
Touch OK key to set the parameter and the processing message will be displayed.

SELECT PROCESS TYPE*

BACKUP USER DATA: To backup the antenna settings set by user to the BDT.

RESTORE USER DATA: To restore the antenna by using the backup user data stored from the BDT.

DEFAULT BDT-REMOTE P/W: to default ID and Password of the Web Server.

UPGRADE FROM USB: to upgrade the system by using the firmware files from a specified folder in the USB flash drive.

COPY LOG TO USB: to copy the antenna log data from the system to the USB flash drive.

BACKUP TO USB: To backup the antenna settings to a specified folder in the USB flash drive.

RESTORE FROM USB: To restore the antenna by using the backup user data from a specified folder in the USB flash drive.

UPGRADE BDT-REMOTE: To upgrade the system using firmware files (FWP) from a specified folder in a USB flash drive.

NOTE: UPGRADE FROM USB, COPY LOG TO USB, BACKUP TO USB, RESTORE FROM USB and UPGRADE BDT-REMOTE options are displayed only if the USB flash drive is plugged into the USB port located in the front panel of the BDT.

Using Aptus PC

Introduction

Intellian's new VSAT Antenna PC Controller Software, Aptus® is a next-generation graphically based antenna remote control software. Aptus® allows users to easily and conveniently set up the antenna by using a personal computer. The minimum PC hardware and software requirements to install and run Aptus® are as follows:

Requirements

Hardware

Hardware	Requirements
CPU	Intel® Pentium® 4 or higher
Memory	512MB or higher
Video Card	DirectX9.0 or higher supported
	H/W acceleration supported
	Video Memory 128MB or higher
HDD	1GB or higher

Operating System and Software

Software	Requirements
Operating System	Windows XP SP or higher
Framework	Microsoft.Net Framework 3.5 Service Pack 1 or higher

Software Installation

Double click the 'Aptus for v-Series Setup.exe' icon  to install Aptus® directly onto your computer/ laptop. The InstallShield Wizard will guide you through the program setup process. The installation routine provides an icon on the desktop.

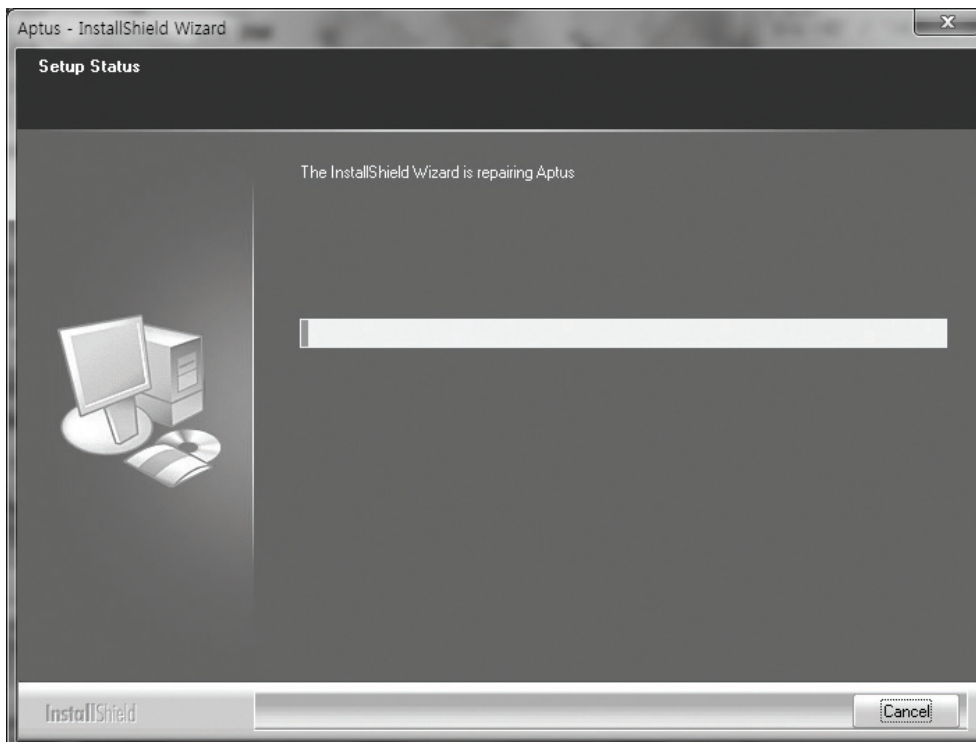

Click the icon to start the software. In addition, Intellian also provides patch files for software upgrade.

PC to BDT Communication Setup

Starting Aptus®

Double-click the Aptus® desktop icon. The Communication Window will appear to establish the data communication between your PC and the BDT. Select your choice of connection method to access your BDT through either the Serial Port Communication or the Network Communication (TCP/IP).

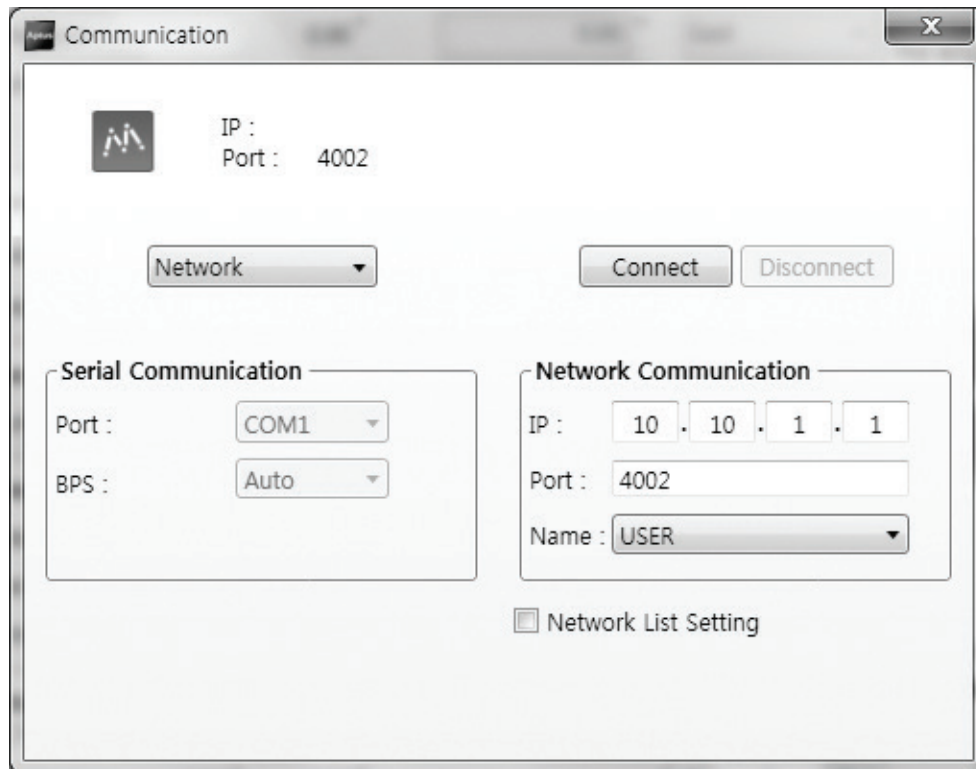

Establish Data Communication

Access BDT through Serial Communication

1. Connect a 9 pin serial cable between the PC INTERFACE connector on the BDT and the 9 pin serial port on the PC. (Or you can use a USB cable to setup serial connection between a PC and the USB port on the BDT.)
2. Select serial at communication type combo-box.
3. The baud rate of the BDT is 57600.
4. Select a COM port which is not occupied by other devices.
5. Click the Connect button.

Access BDT through Network Communication (TCP/IP)

1. Turn off the wireless connection while using this method.
2. Connect your PC to the Management Port. (See 'PC to BDT Communication Setup' section for other network connection methods.)
3. Select Network at communication type combo-box.
4. Enter in the BDT's IP address (Factory default : 192.168.1.2)
5. Enter in the BDT's port number (Factory default : 4002)
6. Click the Connect button then the Authentication window will appear.
7. Login by using the username and password below:
 - Username: intellian (Factory default)
 - Password: 12345678 (Factory default)

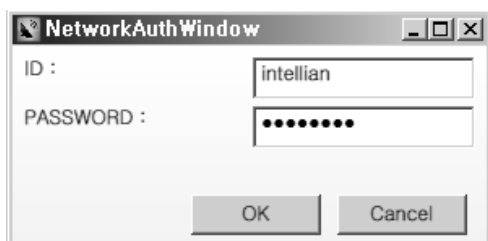

NOTE: If the remote access PC is located in the same network group with the BDT, the BDT can be accessed through the internal IP address. But, if the remote access PC is located outside of the network group, the BDT's IP address should be changed to the IP address assigned by the network service provider.



WARNING:

- Do not plug a USB to the BDT while TCP/IP communication is in use. Doing so will disable current PC Software Control because the USB connection has higher priority than TCP/IP connection.
- The amount of data will increase rapidly if Network Communication is in use. Intellian recommends using Aptus Web.

Auto Update

Intellian Aptus® checks and notifies the latest version when it is started to maintain up to date software version by AutoUpdate function.

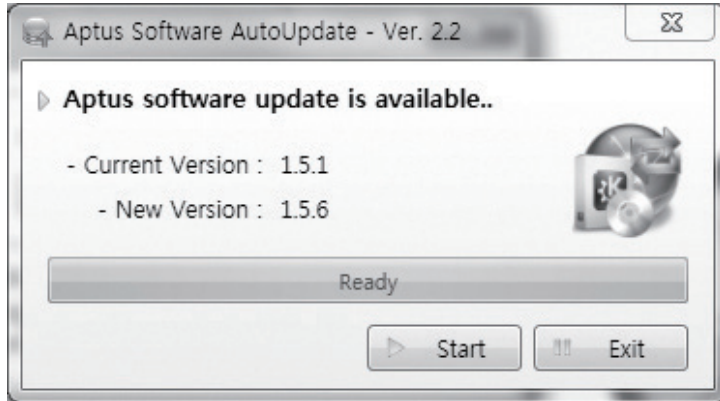

1. When Aptus® is started, it automatically checks the latest software version from the server and runs AutoUpdate if new version is available.
2. Current software version information is displayed.
3. It notifies new software version information.
4. When you click the “start” button, “File downloading...” message is displayed while downloading files from the server.



5. When file downloading is finished, “installing...” message is displayed and Aptus patch runs. The installation starts by InstallShield.
6. Click the “Finish” button when InstallShield installation is finished, then “Run the Aptus” message is displayed and Aptus runs and AutoUpdate is automatically finished.

Toolbar Menus

The toolbar menus at the top of the screen display command buttons of the most commonly used functions of the Aptus®. The toolbar menu consists of four main menus: Quick (for quick launch of functions), File (for file backup, restoring and loading), View, and Connection.

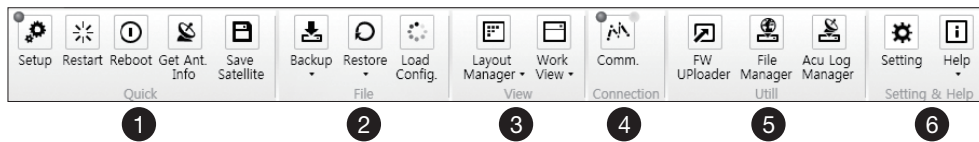

① Quick



Setup: enters Setup mode.



Restart: exits Setup mode and restarts the antenna.



Reboot: reboots the antenna.



Get Ant. Info: obtains the information stored in the antenna



Save Satellite: saves the current bow offset only if the antenna is tracking onto the satellite. The satellite acquisition time can be reduced significantly after the antenna is restarted.

② File



Backup: backups the antenna information to BDT or PC.

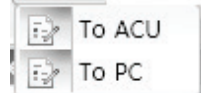

- Select 'To BDT' to backup the antenna information to BDT. The backup file (file format: *.ibf) will be stored on the BDT.

- Select 'To PC' to backup the antenna information to a PC. The backup files (file format: *.rpt and *.ibf) will be generated on the PC.

NOTE: Both *.rpt and *.ibf files contain antenna information. However, while *.ibf file can be used for restoring antenna information, *.rpt file is stored as plain-text for viewing purpose only. Users can open the *.rpt using text editors such as notepad software.

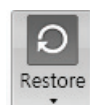

Restore: restores the antenna by using the stored information in BDT or PC.

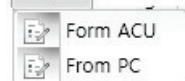

- Select 'From BDT' to restore the antenna by using the stored information in BDT.

- Select 'From PC' to restore the antenna by using the stored information in PC (file format: *.ibf).

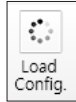

Load Config. : loads the antenna configuration file (file format: *.cfg). The configuration file includes the antenna control parameters which are pre-loaded at the factory and should only be changed by an authorized service technician. Improper setting of these parameters will cause your system to perform improperly.

③ View



- **User Layout:** displays the layout list that the user has previously stored by using Layout Manager. If you select a layout in this list, the selected layout will be constructed in Work View screen. The 'Basic layout' is provided by default.

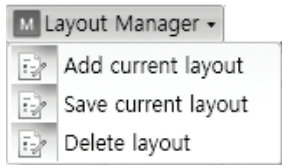

- **Layout Manager:** provides the user with add, delete, and save functionalities in order to manage the user's layouts.
 - Selecting 'Add current layout' opens a pop up window. Type in a desired name of current layout and click Add, then the new name of the current layout will be saved to the list under User Layout menu.
 - When changes are made to the current layout, select 'Save current layout' option. The current layout will be saved with changes.
 - To remove a layout, select 'Delete layout' option. Select a desired layout to remove on the pop up window, then click 'Delete'. Close the window by clicking on 'Close'. The selected layout is removed from the User Layout list.

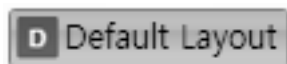

- **Default Layout:** returns the current layout to the default layout.

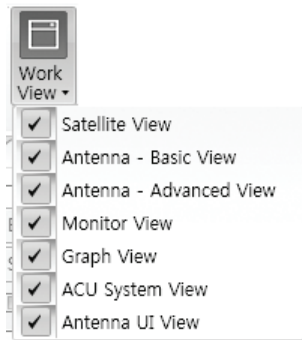

- **Work View:** displays a list of seven pre-constructed Work View Tabs (Satellite View, Antenna Basic View, Antenna Advanced View, Monitor View, Graph View, Diagnostic/Modem View and GUI View) and also provides the Activate / Close functionalities for each view tab. Activate the work view tab by ticking the checkbox next to it.

④ Connection

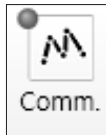

- **Communication:** At any time, data communication channel can be re-established between Serial and Network connection. Selecting Comm. Button will display Communication Window to connect to the BDT via Serial or Network communication.

⑤ Util



- **Firmware Uploader:** provides the user with the latest firmware version and updates firmware by simple steps.

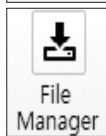

- **File Manager:** display the latest firmware and library file available on Aptus Server. Select a desired firmware and download to the local PC.



- **BDT Log Manager:** displays the antenna log data in calendar view which is downloadable directly to a desired path.

⑥ Help



- **Setting:** enables or disables Auto Update function and sets network connection time-out.



- **Help:** 1) Report: provides e-mail contact to Intellian technical support team to let the user report problems at any time. 2) Information: displays the information of current Aptus® software version.

System Property Status Dashboard

The property status dashboard on the left pane of the screen provides the antenna status, the availability of TX transmission, signal level, GPS and heading status, software information, product information and error status to be monitored quickly.

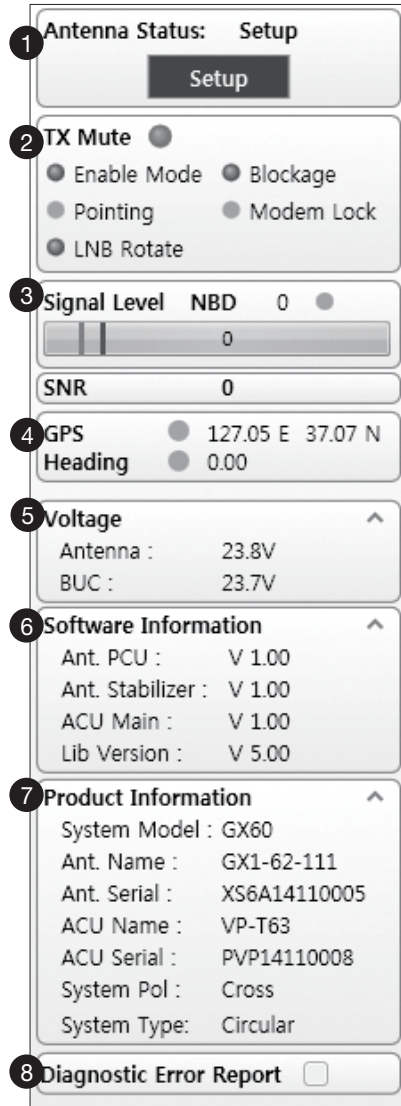

- ① Antenna Status: Displays the status of the current mode of the antenna.
- **Search 1:** A Search 1 pattern will automatically be initiated when the ship's heading input does not exist or if it fails. The search cycle will repeat until the antenna receives the lock signal from the modem or until the DVB transponder of the target satellite is decoded by the antenna.
 - **Search 2:** Search 2 is reserved for future use.
 - **Search 3:** Search 3 pattern will automatically be initiated when AGC(DVB mode is in use) or SIG/dB (NBD mode is in use) falls below the current tracking level threshold value. Once the desired signal is found and above the predefined tracking threshold, the BDT will enter to tracking mode.
 - **Tracking:** Antenna is tracking the target satellite.
 - **Initialize:** Antenna or BDT is initializing.
 - **Setup:** Antenna is in SETUP mode.

② TX Enable

Displays the status of TX transmit. If the circle next to the TX Enable shows “Blue”, it means the antenna TX function is enabled. If the circle shows “Red”, it means the antenna TX function is disabled. The TX function will be enabled only if all five factors (Enable Mode, Blockage, Pointing, Modem Lock, and LNB Rotate) listed below show a “Blue” circle. However, if the “Use TX Mute” function in the ‘BDT System’ Work Tab is disabled, the TX function will be enabled regardless the above factors.

- **Enable Mode:** displays whether or not the antenna is in transmitting.
- **Blockage:** displays whether or not the antenna is pointing in a predefined block zone(s). If the antenna is pointing in the block zone, the circle next to the Blockage will show “Gray”. If the antenna pointed outside the block zone, the circle next to the Blockage will show “Blue”.
- **Pointing:** displays whether or not the antenna is pointing to the target satellite. If the antenna is mis-pointing to the target satellite, the circle next to the Pointing will show “Gray”. If the antenna is pointing to the target satellite, the circle next to the Pointing will show “Blue”.
- **Modem Lock:** displays whether or not the modem is locked by receiving a confirmation signal from the satellite modem. If the modem is not locked, the circle next to the Modem Lock will show “Gray”. If the modem is locked, the circle next to the Modem Lock will show “Blue”.

NOTE: If the Modem Lock shows “Gray”, check the cable connection between the antenna system and the satellite modem as well as settings on the modem.

- **LNB Rotate:** displays whether or not the LNB is rotating. If the LNB is rotating, the circle next to the LNB Rotate will show “Gray”. If the LNB is not rotating, the circle next to the LNB Rotate will show “Blue”.

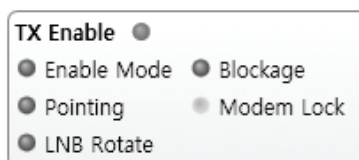

- ③ **Signal Level**
Shows “DVB” when DVB mode of tracking signal is in use and “NBD” when NBD mode of tracking signal is in use. The “Red” line indicates the signal “Detect Level Threshold” and the “Orange” line indicates the signal “Tracking Level Threshold”. If the signal level is higher than the tracking level threshold, the signal level bar will display “Blue” color. If the signal level is lower than the tracking level threshold, the signal level bar will display “Orange” color and the antenna will stay in searching mode.

NOTE: If the signal level is not higher than the tracking threshold, decrease the detect and tracking level.

- ④ **GPS and Heading**
Displays the current GPS location from the Antenna and Ship’s heading information. The status light flashes green if the system receives a correct input of the GPS and Ship’s heading.

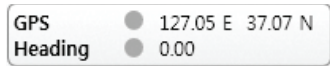

Voltage: Displays the antenna and the BDT voltage information.

- ⑤

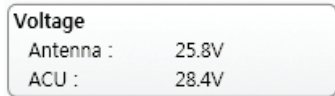

Software Information: Displays the antenna and the BDT firmware versions, and the

- ⑥ library version.

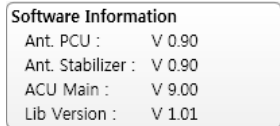

Product Information: Displays the antenna and BDT serial numbers, antenna model and BDT model.

- ⑦

- ⑧ **Diagnostic Error Report**

The square button next to the Diagnostic Error Report turns red when the system receives an error. Click the button to see a Diagnostic Report.

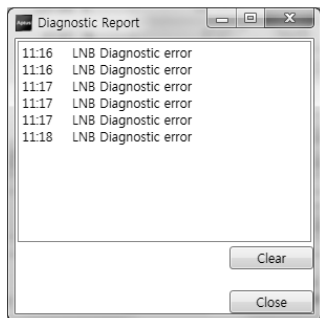

Work View Tabs

Aptus® provides seven Work View Tabs (Satellite View, Antenna Basic View, Antenna Advanced View, Monitor View, Graph View, Diagnostic/Modem and GUI) to manage the Antenna and the Satellite configuration.

How to modify the settings on Work View:



1. Enter the Setup mode by clicking Setup icon.

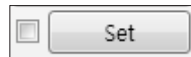

2. Tick the checkbox next to the “Set” button to modify the settings.
3. Enter the desired value then press the Set button to save the settings.

1. Antenna – Basic Info.

This view tab provides information on the Antenna’s Current GPS location, Heading Device, Bow Information, Skew Information, and the Antenna’s Angle. This view tab uses the Antenna’s AZ and EL information as well as the Ship’s Heading information in order to provide a dynamic graphic user interface (UI).

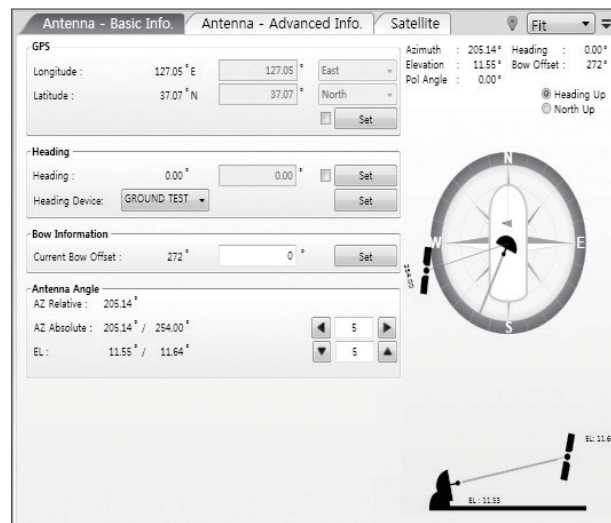

- **GPS:** displays and sets current antenna’s GPS.

- **Heading:** displays and sets current ship’s heading information.

- Heading Device: None / NMEA/ NMEA 2000/Ground Test.
The baud rate (4800/ 9600/ 19200/ 38400) must be set if NMEA is selected.

- **Bow Information:** displays and sets current antenna’s bow.

- **Antenna Angle:** displays and sets current antenna’s absolute and relative AZ (azimuth) position, EL (elevation) position and LNB Pol angle. You can move antenna azimuth and elevation position and LNB Pol angle by using the arrows or inputting a value to find the desired satellite manually.

2. Antenna – Advanced Info.

This view provides information on the Tilt Sensor Bias, Conical Range, EL Adjust, Rate Sensor, Search Parameter and Block Zone.

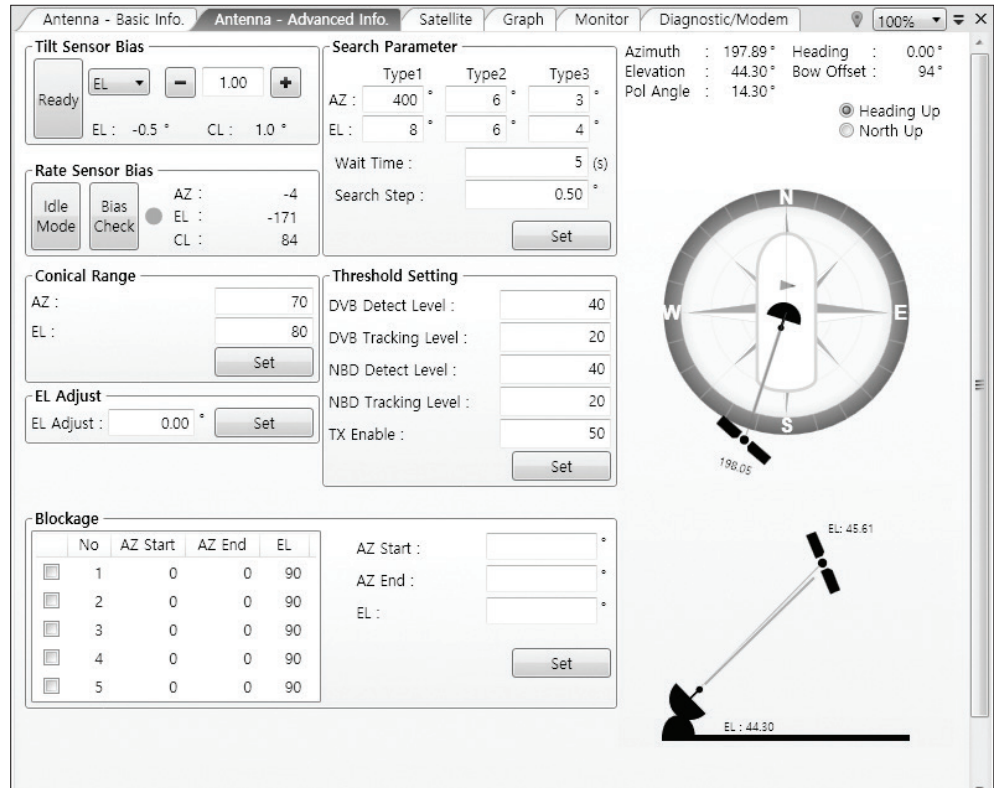

-Tilt Sensor Bias: This maintains the elevation and the cross level axes in order to keep the pedestal parallel to the horizon. Adjust the two solid-state tilt sensors to provide absolute cross-level tilt of the antenna and elevation feedback to eliminate long-term pointing drift (error). Tilt bias must be adjusted when the antenna control board or sensor box is replaced. If the bubble on the button level located on the sensor box is not centered, follow the steps below to adjust the tilt sensor bias.

- Step 1. Enter Setup mode and press the “Ready” button to bring the elevation and cross-level to 0.
- Step 2. Select “EL” from the drop down list and press Up and Down arrow keys to adjust the bubble until it is located in the center ring of the button level.
- Step 3. Select “CL” from the drop down list and press Up and Down arrow keys to adjust the bubble until it is located in the center ring of the button level.



- Step 4. Press the “Restart” icon to restart the antenna.

- **Rate Sensor:** is used to calibrate the DC voltage output from the three rate sensors (azimuth, elevation, and cross-level). These are used to sense antenna motion that corresponds to the ship’s motion (roll, pitch, and yaw) for stabilizing the pedestal. The DC voltage output from each of the rate sensors may vary by an amount which is directly proportional to the direction and rate of motion induced on it.

Before calibrating the rate sensors located in the Sensor box, make sure that the antenna is placed on a rigid and flat platform. During the calibration process, any motion of the antenna should be avoided as it can affect the antenna’s performance. Proceed with the following steps to perform the calibration.

- Step 1. Enter Setup mode
- Step 2. Press the “Idle Mode” button to release the elevation and cross level motor brakes while the antenna is in Setup mode.
- Step 3. Check whether or not the bubble is located at the center of the button level. If not, move it to the center by following the previous instruction of Tilt Sensor Bias adjustment.
- Step 4. Press the “Bias Check” button to calibrate the rate sensor. A blue circle will be displayed next to the Bias Check button if the calibration is completed. A red circle will be displayed if calibration failed. A green circle will be displayed during the calibration process.

- **Conical Range:** The relative force of the motors controlling azimuth and elevation. Set the conical range while the antenna is in tracking mode.

- **EL Adjust:** The elevation adjustment is to offset the angle difference between the mechanical elevation angle and actual elevation angle. If this value is not properly adjusted, the antenna may take longer time for satellite search or tracking.

- **Search Parameter:**

- Wait time: set the time-out for automatic initiation of a search after the signal level drops below the pre-defined threshold value.

- Search Step: set increment step size.
- Type 1 & Type 3 (Search 1 & 3) Range: set Search 1 & 3 search range. Search 3 is conducted in a two-axis pattern consisting of alternate movements in azimuth and elevation as it forms an expanding square.
- Type 2 (Search 2) Range: is reserved for future use.

- Block Zone

Displays current block zones by azimuth and elevation sectors. Up to 5 block zones can be programmed. Once the block zone is created, a blue shading area will be displayed in the Antenna UI view on the right.

- Threshold Settings

- DVB Detect Level: displays and sets signal detection threshold level when DVB tracking mode is in use.
- DVB Tracking Level: displays and sets signal tracking threshold level when DVB tracking mode is in use.
- NBD Detect Level: displays and sets signal detection threshold level when NBD tracking mode is in use.
- NBD Tracking Level: displays and sets signal tracking threshold level when NBD tracking mode is in use.
- TX Enable Threshold: displays and sets TX enable threshold.

3. Satellite

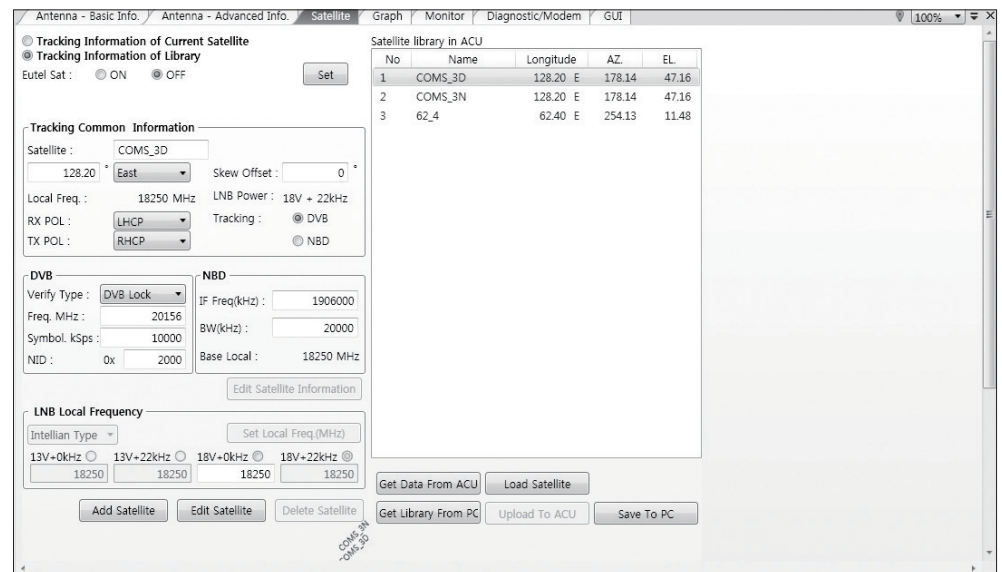

This view provides information on the Satellite's Information, Tracking Common Information, DVB and NBD Tracking Transponder, LNB Local Frequency, and Satellite Library. This view shows a graphic UI of the current satellite that the antenna is pointing at and the satellites that are located at a 180° arc on the horizon with reference to the current position.

NOTE: Based on the satellite EIRP footprint and the size of the antenna, you may not be able to track all the satellites visible in 180° arc.

- **Tracking Information of Current Satellite:** displays the current satellite's name, longitude position, and satellite skew of the satellite in the library.

- **Tracking Common Information:** displays the current LNB local oscillator frequency that is in use and the corresponding voltage supplied. Selects the tracking mode (DVB / NBD) to be used and sets polarization (Horizontal / Vertical) for the RX pol and the TX pol.

- **DVB / NBD:** sets tracking transponder information for either DVB tracking mode (Verification Type, Frequency, Symbol rate, and NID) or NBD tracking mode w(Frequency and bandwidth).

NOTE: DVB and NBD parameter settings should only be changed by an authorized service technician. Improper setting of these parameters will render your system inoperable. Consult Intellian for changing antenna parameters.

- **LNB Local Frequency:** Displays or sets LNB local frequency and its corresponding LNB voltage supplied. You may select pre-programmed LNB LO settings from the drop down list. This procedure is same for both the Intellian Global VSAT PLL LNB and any other LNB.

- **Tracking Information of Library:** Selecting this option enables “Add Satellite”, “Edit Satellite”, and “Delete Satellite” buttons.

- **Eutelsat:** Select 'ON' when the antenna is tracking an Eutelsat satellite. With this option enabled, a defined skew angle for each Eutelsat satellite is automatically applied without allowing a manual modification to the skew offset value.
- **Get Library From PC :** opens the satellite library file (File format:*.lif) from the PC.
- **Get Data From BDT:** obtains the satellite information from the BDT.
- **Load Satellite:** uploads the satellite information to the BDT.
- **Upload to BDT:** uploads the satellite library to BDT.
- **Edit Satellite:** edits the satellite information of the selected satellite. When Eutelsat satellite is selected, enable Eutelsat option. This applies defined skew angles for each Eutelsat satellite automatically and doesn't require manual modification.
- **Add Satellite:** adds the satellite information as defined in the current settings.
- **Delete Satellite:** deletes the selected satellite from the library.
- **Save to PC:** saves the current library settings to PC.

NOTE: It is required to click the "Save to PC" button after "Edit Satellite", "Add Satellite", or "Delete Satellite" button is clicked.

4. Graph View

This view provides information on Signal, Elevation (EL), Absolute AZ (Azimuth), Relative AZ, Heading, AZ and EL in Single or Multi graph formats.

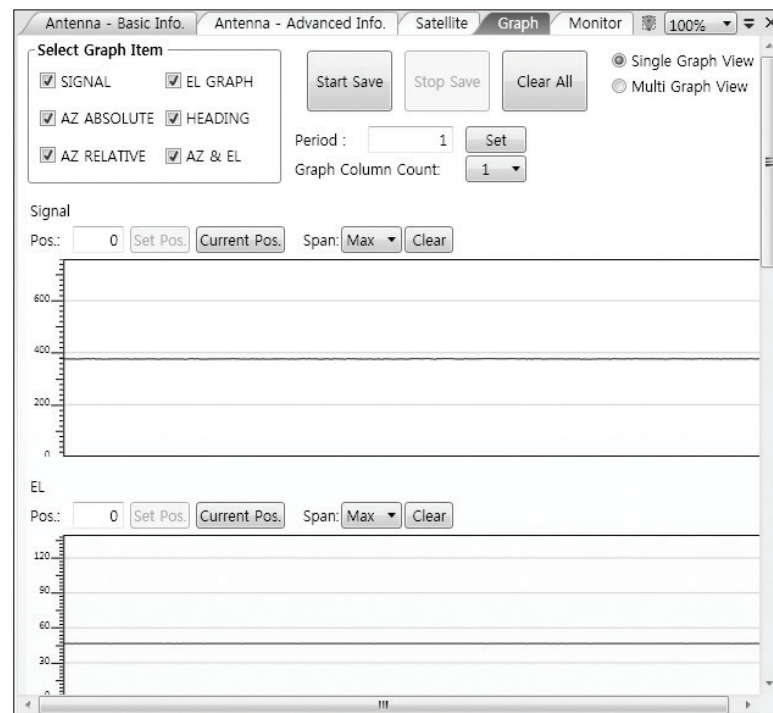

- **Select Graph Item:** shows the graphs of only the checked item(s) in a Single or Multi Graph View.
- **Single Graph View:** shows Graph Views per each single Graph Item selected in 'Select Graph Item'.
- **Multi Graph View:** shows one large integrated Graph View of multiple Graph Items selected in 'Select Graph Item'.
- **Start/Stop Save:** the chosen item is saved within the data log. The data log which stores the information displayed in the graphs can be later used for a service technician to find out a cause of any possible problem to the antenna.
- **Clear All:** clears everything drawn on the Graph View window.
- **Set Pos.:** sets the current position as center value of each Graph Item.
- **Current Pos.:** moves to the location according to values of each Graph Item.
- **Span:** sets the Display Range(s) of each corresponding Graph Item.
- **Period:** displays and sets the signal sampling rate.
- **Graph Column Count:** makes all Graph Views show in either one or two-column format.

5. Monitor

This view provides a UI which can monitor all data that has been received from the BDT.

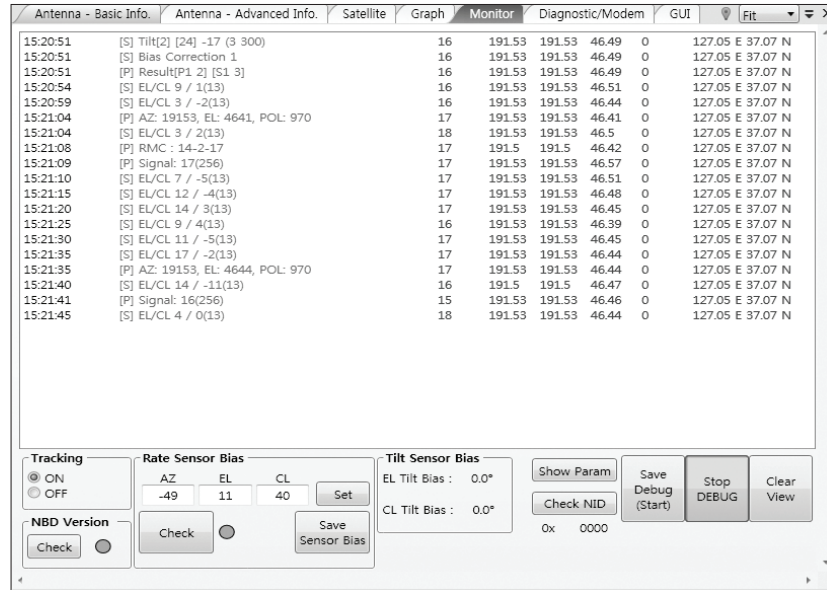

- **Tracking:** turns on or off the dish scan function. If the dish scan function is disabled, the antenna will stop adjusting the antenna pointing angle in order to optimize the receive signal level.
- **Rate Sensor Bias:** is used to calibrate the DC voltage output from the three rate sensors (azimuth, elevation, and cross-level). These are used to sense antenna motion that corresponds to the ship’s motion (roll, pitch, and yaw) for stabilizing the pedestal. You can find the same function in Antenna-Advanced View Tab.
- **Show Param:** shows the current antenna parameters.
- **Check NID:** verifies the NID (network ID) of the current tracking transponder. Press the NID button to obtain the NID only if the antenna is locked onto the desired satellite .
- **Debug (Start):** starts the debug log of the antenna. The debug message will be displayed once the debug button is pressed.
- **Stop Debug:** stops debug logging of the antenna.
- **Save Log (Start/Stop):** starts or stops the logs of the antenna. This button will be enabled while viewing the debug log. The log message will be stopped or be saved into a *.txt file once the log button is pressed. (V_Date.txt.)
- **Save Debug (Start/Stop):** starts or stops saving the debug log. This button is enabled once the Start Debug button is pressed.
- **Clear View:** clears the debug message or log data in monitoring window.

6. Diagnostic / Modem

This view provides Antenna Diagnostic Testing and also provides functions to set up the interface between the BDT and the Intellian VSAT Mediator or the satellite modem.

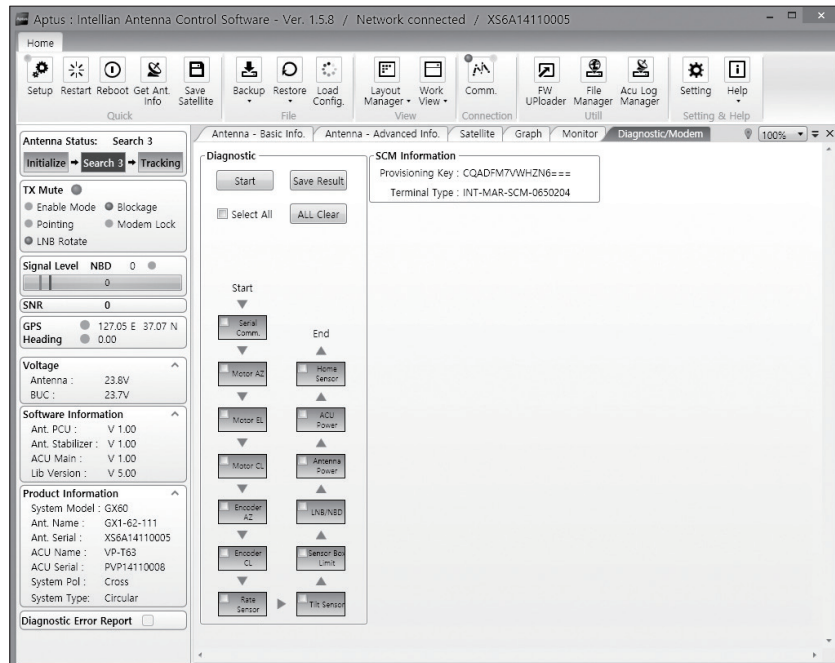

- **Diagnostic** : select to run a full diagnostic test or single diagnostic test.

"Green" indicator is displayed for the test under progress.

"Blue" indicates the test result as Pass while "Red" indicates the result as Fail.

"Yellow" indicates the test has been skipped.

- **Serial Comm.:** tests the data communication between the antenna and the BDT.

- **Motor AZ:** tests the azimuth motor.

- **Motor EL:** tests the elevation motor.

- **Motor CL:** tests the cross-level motor.

- **Encoder AZ:** tests the azimuth encoder.

- **Encoder CL:** tests the cross-level encoder.

- **Rate sensor:** tests the rate sensor.

- **Tilt Sensor:** tests the tilt sensor.

- **Home sensor:** tests the home sensor.

- **BDT power:** tests the BDT power to see whether or not it is within the nominal operating range.

- **Antenna power:** tests the antenna power to see whether or not it is within the nominal operating range.

- **LNB/ NBD:** tests the LNB and NBD (narrow band detector).

- **Sensor Box Limit:** tests the sensor box motor .

- **SCM Information:** displays the modem information.

7. GUI

This view shows a graphical representation of the current antenna position which allows you to easily identify whether or not the antenna is aligned properly to the target satellite or is in a block zone. In addition, this view shows the current satellite that the antenna is pointed towards and the satellites that are located at a 180° arc on the horizon, according to the current position.

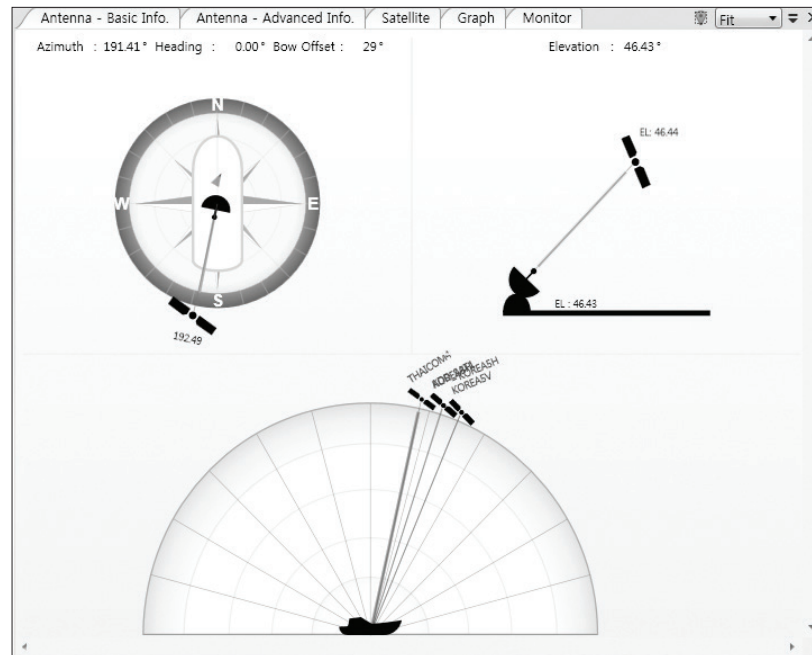

NOTE: Based on the satellite EIRP footprint and the size of the antenna, you may not be able to track all the satellites visible in 180° arc.

8. Work View Functions

The seven Work View Tabs displayed in the Work View can be arranged in customized layouts.

- Layout Formatting

- Each of the Work View Tabs can be separated from the rest of the Tabs. Click and hold the left mouse button on the Work View Tab's header and then drag a desired Tab out. When a Work View Tab is separated from the rest of your Work View Tabs, again click and hold the left mouse button on the Work View Tab's header to display a cross-shaped Navigator icon. While holding the mouse button, bring the selected Work View Tab closer to the Navigator icon and release the mouse button at your desired position (top, left, right or bottom arrow). This time, the selected Tab will be moved to the desired position.

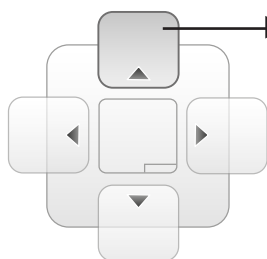

Move the selected Work View Tab to the top position of the Work View layout. (See example figure below where Antenna – Basic Info Tab is moved to the top)

The screenshot shows the 'Antenna - Basic Info' tab selected and moved to the top position. The interface includes the following sections:

- GPS:** Longitude: 127.05° E, Latitude: 37.07° N, Azimuth: 191.42°, Elevation: 46.39°, Pol Angle: 9.70°, Heading: 0.00°, Bow Offset: 29°.
- Heading:** Heading: 0.00°, Heading Device: GROUND TEST.
- Bow Information:** Current Bow Offset: 29°.
- Satellite:** Tracking Information of Current Satellite, Tracking Information of Library, Edit Satellite, Tracking Common Information.
- Satellite library in ACU:**

No	Name	Longitude	AZ	EL
1	KOREA3H	116.00 E	198.05	45.61
2	KOREASV	113.00 E	202.66	44.67
3	KOREASH	113.00 E	202.66	44.67
4	THAICOM4	119.50 E	192.49	46.44
5	ADD_SAT1	116.10 E	197.90	45.64

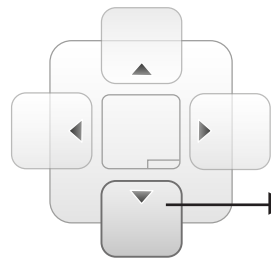

Move the selected Work View Tab to the bottom position of the Work View layout.

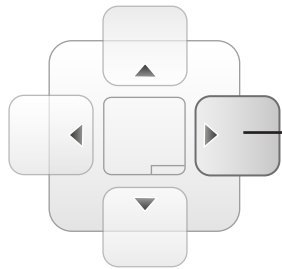

Move the selected Work View Tab to the right position of the Work View layout.

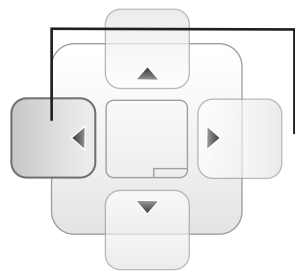

Move the selected Work View Tab to the left position of the Work View layout.

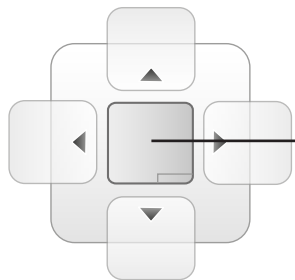

Move the selected Work View Tab to the center position of the Work View layout.

You can also drag multiple Work View Tabs into a customized layout in the same manner. Click and hold left mouse button on each Work View Tab's header and drag it onto a desired arrow on the Navigator icon. Then each Work View Tab can be placed to the desired positions as shown in the figure below.

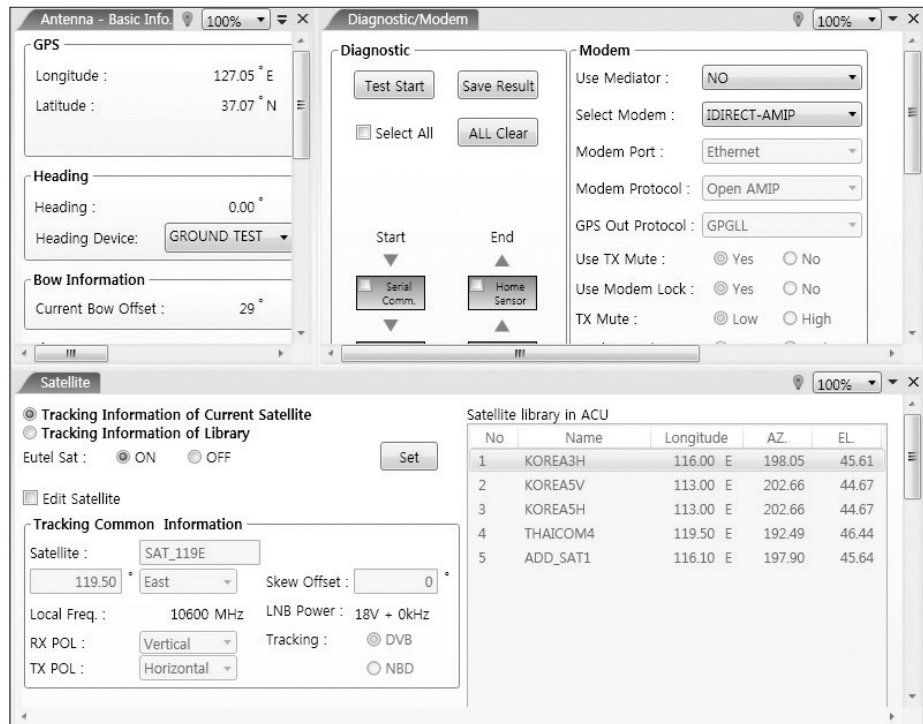

The Navigator will appear in each area your mouse pointer is located. To return to the default layout, select the Default Layout toolbar menu.

- Horizontal or Vertical Tab Group

The Work View Tabs can be also aligned horizontally or vertically. Without dragging them out, right-click the mouse button on a desired Tab header and select 'New Horizontal Tab Group' or 'New Vertical Tab Group' option. Selecting 'New Horizontal Tab Group' will separate a selected Tab from the rest of other Tabs then arrange it in a horizontal format. Likewise, selecting 'New Vertical Tab Group' will separate a selected Tab from the rest of other Tabs then arrange it in a vertical format.

- Closing the Work View Tab

To close the Work View Tab, right-click the mouse button on a desired Tab header and select 'Close' option in the drop down list. To close all Work View Tabs except the selected Tab, select 'Close All But This' option in the drop down list.

- Zoom Tool

Using the Zoom tool, you can easily select the magnification you want by using Zoom In and Zoom Out bar, and Fit in Work View button.



Fit Work View Button: fits the current view to the Work View window size. The button toggles between the fit view and the previous view.

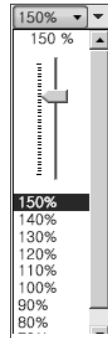

Zoom In and Zoom Out Bar: zooms in and out to expand and reduce the View to the desired size. (The zoom changes in 10% increments.)



View Switch Button: displays a list of the current views in a list. Choosing one of these views will display the selected view in the Work View window.



View Name Button: displays the current Work View name.



Close View Button: closes the current view.

Using Aptus Web

Introduction

With embedded Remote Access (Aptus Web) function, the v-Series can be monitored, controlled, and diagnosed remotely from anywhere, anytime through the TCP/IP protocol. This not only can save time but also saves the cost generated from the hundreds of routine maintenance activities, such as operating firmware upgrades, tracking parameters resets, and system diagnostic.

How to access Aptus Web:

1. Connect an Ethernet Cable between your PC and the Management Ethernet Port.
2. Enter the BDT's IP address (**192.168.1.2**) into your web browser's address bar to login into the BDT's internal HTML page, if this system has not been changed from the BDT's factory default.

NOTE: Aptus Web can be displayed in Internet Explorer 7 or later and is also compatible with Firefox and Chrome web browser.

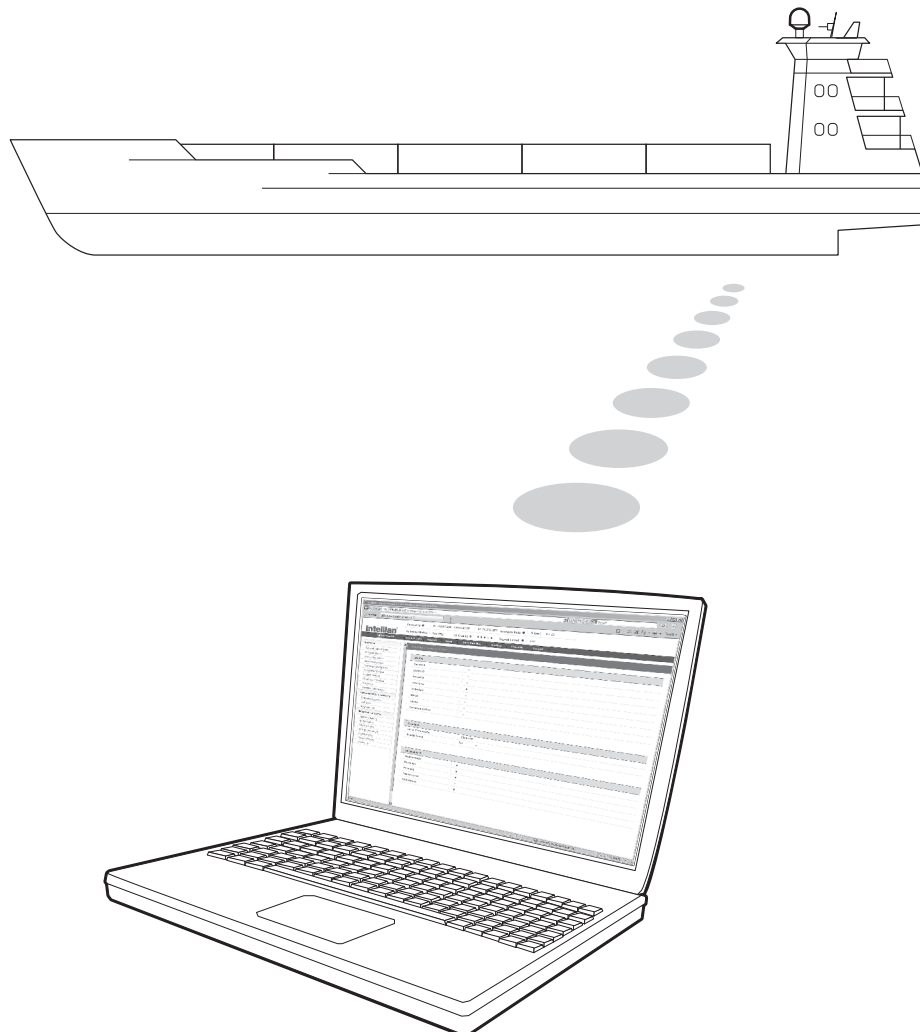

Main Page

Page Login

1. Choose either to Control & Monitor the BDT (Control & Monitoring) or Only Monitor the BDT (Monitoring Only).
2. Log into the BDT by typing in User Name and Password information. If this system has not been changed from the factory default:

- **User Name:** intellian
- **Password:** 12345678



WARNING: The Control & Monitoring Mode will be switched to the Monitoring Only Mode in the following cases;

- If Aptus is connected using TCP/IP Communication while Aptus Web Control is in use.
- If Control & Monitoring Mode is accessed while PC Software is running via TCP/IP Communication. In this case, the web page will display a pop-up message asking if you want to disconnect the PC Software network connection. If you select 'No', the Control & Monitoring Mode will be switched to the Monitoring Only Mode.

Top Menus

Once you log in, the following information and menus are displayed.

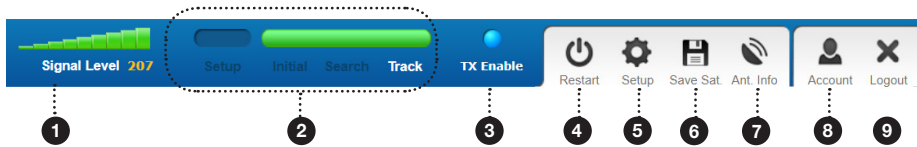

No.	Item	Description
①	Signal Level	Display current signal level.
②	Antenna status	<ul style="list-style-type: none"> - Setup: Displays whether or not the antenna is in SETUP mode. The indicator shows "Blue" in the SETUP mode. - Initial: Antenna or BDT is initialized. - Search: Antenna is searching a target satellite. - Track: Antenna is tracking the target satellite.
③	TX Enable/ TX Disable	Displays whether or not the antenna is able to transmit the data.
④	Restart	Restart the antenna system.
⑤	Setup	Enter SETUP mode.
⑥	Save Sat.	Save current satellite settings. Bow offset will be adjusted and saved automatically.
⑦	Ant. Info	Obtain current antenna information.
⑧	Account	Shortcut to User Management menu. Change login ID and Password.
⑨	Logout	Logout the BDT's internal HTML page.

Dashboard & Information

On the left side of the page, Dash Board and Information menus are displayed as below to provide quick monitoring of the antenna status and settings. Other menus are displayed only in the Control & Monitoring mode and their functions will be described in the next sections.

1 Dashboard

- > Ship Setting
- > Antenna Setting
- > Tracking Setting
- > Diagnostic
- > Library Setting
- > Firmware&Configuration
 - Antenna Firmware Upgrade
 - Antenna Log
 - Antenna Backup & Restore
- > Administration
 - Network Setting
 - User Management
 - IARM Upgrade
 - IARM Save & Reboot
 - Antenna Event Log
 - Modem Information

15 Information

Control IP • 192.168.1.222
 Current IP 192.168.1.222
 Refresh Rate • 1 (sec)
 Refresh Disable 4.33
 Idle Session Timeout 25:33
 Time 07:07:50 (UTC)
 Date 2017-11-30
 Wifi

2 Dashboard Antenna1-

3 Current Antenna Position / Target Antenna Position

Relative Azimuth(°)	114.22
Absolute Azimuth(°)	114.22 / 114.73
Elevation(°)	21.49 / 21.00

4 GPS

Longitude(°)	127.083626	E
Latitude(°)	37.120750	N

5 Heading Device

Current Device
 GROUND TEST
 Heading(°) 0.00

6 BOW Offset

Current Bow Offset(°) 154

7 DVB Information

Frequency(MHz)	19736
Symbol(kSps)	20000
NID	0x 0001
Verify Type	AGC Only

8 NBD Information

IF Frequency(kHz)	1486500
Bandwidth(kHz)	24992
Base Local	18250 Mhz

9 Local Frequency Setting(MHz)

13V + 0kHz	18250
13V + 22kHz	18250
18V + 0kHz	18250
18V + 22kHz	18250

10 Software Information

Antenna Stabilizer Version	V 1.05
Antenna PCU Version	V 1.06
ACU Main Version	V 1.06
Library Version	V 5.00

11 Azimuth Animation

12 TX Enable

- Enable Mode
- Blockage
- Pointing
- Modem Lock
- LNB Rotate

13 Tracking Satellite

Satellite Name SAT_179E
 Longitude(°) 179.6 E
 Skew Offset(°) 0.00
 Tracking Method DVB NBD
 RX Polarization LHCP
 TX Polarization RHCP

14 Antenna Information

Antenna Size	100 cm / 41 inch
Voltage	24.2V / 24.3V
Antenna Product	V3-11G-311
ACU Product	VP-T63
Antenna Serial Number	XS0A15020033
ACU Serial Number	PVP17061725
System Polarization	Circular Only
System Band	KA BAND

15 SCM Information

Provisioning Key	CQALD4SP5OQMS===
Terminal Type	INT-MAR-SCM-1000200

No.	Item	Description
①	Dashboard	Displays current antenna status to be quickly monitored.
②	Current Antenna Name	This function is available when: <ul style="list-style-type: none"> • the antenna is connected to GX Mediator and GX BDT at the same time. • "Dual Diversity Configuration" is in "Activate" status. You can select status on the "Network Setting" menu. Displays the current antenna name as "Dashboard-Antenna 1 or 2-XX"(XX is antenna description). You can set the description by accessing GX Mediator Web Server: 192.168.1.4 For more information, refer to the "Mediator User Guide" that came with the GX Mediator package.

③	Current Antenna Position / Target Antenna Position	Displays current antenna position. - Relative Azimuth: displays antenna relative AZ angle. - Absolute Azimuth: displays antenna absolute AZ angle. - Elevation: displays antenna elevation angle.
④	GPS	Displays current GPS information. - Longitude (East / West) - Latitude (North / South)
⑤	Heading Device	Displays current Heading Device: NONE, NMEA, NMEA 2000, GROUND TEST. If the ship's gyrocompass input is other than NMEA separate purchase of NMEA Converter is required. - Heading: displays ship's heading information.
⑥	BOW Offset	Display current bow offset.
⑦	DVB Information	Displays DVB tracking mode's current tracking information. - Frequency: displays tracking frequency. - Symbol rate: displays symbol rate. - NID: displays network ID. - Verify type: displays verification type(AGC, DVB, DVB Decode).
⑧	NBD Information	Displays NBD tracking mode's current tracking information. - IF Frequency: displays tracking IF frequency. - Bandwidth: displays detection bandwidth. - Base Local: displays base local frequency.
⑨	Local Frequency Setting (MHz)	Displays current LNB's local frequency and voltage.
⑩	Software Information	Displays current Antenna and BDT firmware versions and Satellite Library version installed in the system. - Antenna Stabilizer Version: displays the antenna stabilizer version. - Antenna PCU Version: displays the antenna PCU version. - ACU(BDT) Main Version: displays the ACU(BDT) Main version. - Library Version: displays the Library version.
⑪	Azimuth Animation	Shows a graphical representation of the current antenna position to identify whether or not the antenna is aligned properly to the target satellite or is in a block zone.
⑫	TX Enable	Displays whether or not the antenna is able to transmit the data. The TX function will only be enabled (shows BLUE dot) only if all of the factors listed below shows "BLUE" dot. - Enable Mode: antenna is not in SETUP mode. - Blockage: antenna is not facing the predefined block zone(s). - Pointing: antenna is pointing to the target satellite. - Modem Lock: satellite modem is sending a logic input to the BDT to identify when the antenna tracks on the correct satellite. - LNB Rotate: LNB is not rotating.
⑬	Tracking Satellite	Displays current tracking mode. - Satellite Name: displays satellite name. - Longitude: displays satellite orbit position. - Skew Offset: displays Skew offset. - Tracking Method: displays current tracking mode (DVB/ NBD). - RX Polarization: displays current RX polarization. - TX Polarization displays current TX polarization.
⑭	Antenna Information	Displays the antenna product information. - Antenna Size: displays the antenna size. - Antenna Product: displays the antenna product name. - ACU Product: displays the ACU product name. - Antenna Serial Number: displays the antenna serial number. - ACU Serial Number: displays the ACU serial number. - System Polarization: displays the system polarization. - System Band: displays the system band.
⑮	SCM Information	Displays the Modem information. - Provisioning Key: displays the provisioning key number. - Terminal Type: displays the terminal type number.

Antenna Settings

Ship Setting

No.	Item	Description
①	Ship Setting	Set the ship information and block zone.
②	GPS	Set GPS information. - Longitude (East/West) - Latitude (North/South)
③	Bow Offset	Set Bow Offset if needed.
④	Heading Device	Set ship’s heading device (NONE, NMEA, NMEA2000, GROUND TEST) and ship’s heading information.
⑤	Blockage	Set the antenna’s block zones up to 5 by azimuth and elevation sectors. AZ. START is where the relative azimuth starts and AZ. END is where the relative azimuth ends (Range: 0 - 360°). EL. Limit is where the elevation starts (Range 0 - 90°).



WARNING: Enter the SETUP mode for configuration. Tick the checkbox before modifying the settings. After configuration, click ‘Set ...’ button to submit the settings.

Antenna Setting

- > Dashboard
- > Ship Setting
- 1 Antenna Setting**
- > Tracking Setting
- > Diagnostic
- > Library Setting
- > Firmware&Configuration
 - Antenna Firmware Upgrade
 - Antenna Log
 - Antenna Backup & Restore
- > Administration
 - Network Setting
 - User Management
 - iARM Upgrade
 - iARM Save & Reboot
 - Antenna Event Log
 - Modem Information
- > Information
 - Control IP • 192.168.1.222
 - Current IP 192.168.1.222
 - Refresh Rate • 1 (sec)
 - Refresh Disable 8:25
 - Idle Session Timeout 29:25
 - Time 07:16:15 (UTC)
 - Date 2017-11-30
 - Wifi

Antenna Setting

2 Current Antenna Position / Target Antenna Position

Relative Azimuth(°)	114.17
Absolute Azimuth(°)	114.17 / 114.73
Elevation(°)	21.49 / 21.00
Heading(°)	0.00

3 Manual Movement

Azimuth Angle(°)

Elevation Angle(°)

4 Elevation Adjust

EL Adjust(°)

5 Conical Range

Azimuth

Elevation

6 Idle Mode

7 Reboot

8 Search & Tracking Parameter Setting

DVB Detect Level Threshold	<input type="text" value="40"/>
DVB Tracking Level Threshold	<input type="text" value="20"/>
NBD Detect Level Threshold	<input type="text" value="40"/>
NBD Tracking Level Threshold	<input type="text" value="20"/>
Tx Enable Threshold	<input type="text" value="60"/>
Wait Time(s)	<input type="text" value="5"/>
Search Step(°)	<input type="text" value="0.50"/>
Search 1 Range(°)	Azimuth <input type="text" value="400"/> Elevation <input type="text" value="8"/>
Search 2 Range(°)	Azimuth <input type="text" value="6"/> Elevation <input type="text" value="6"/>
Search 3 Range(°)	Azimuth <input type="text" value="3"/> Elevation <input type="text" value="4"/>

9 BUC Keyline Option

Activate

10 Tilt Sensor Bias

Tilt Sensor

Elevation
 Cross Level

Step(°)

11 Rate Sensor Adjust

Azimuth

Elevation

Cross-level

•

No.	Item	Description
①	Antenna Setting	Set current antenna position and Search and Tracking parameters. These parameters should only be changed by an authorized service technician. Improper setting of these parameters will render your system inoperable.
②	Current Antenna Position/ Target Antenna Position	Display current antenna position. - Relative Azimuth: display antenna relative AZ angle. - Absolute Azimuth: display antenna absolute AZ angle. - Elevation: display antenna elevation angle. - Heading: display ship's heading information.
③	Manual Movement	Move antenna azimuth and elevation angles to find the desired satellite manually.
④	Elevation Adjust	Adjust the elevation to offset the angle difference between the mechanical elevation angle and actual elevation angle.
⑤	Conical Range	The relative force of the motors controlling azimuth and elevation. Set the conical range while the antenna is in tracking mode.
⑥	Idle Mode	Release the elevation and cross level motor brakes while the antenna is in SETUP mode. The antenna can be moved manually during the mode.

95

⑦	Reboot	Reboot the system.
⑧	Search & Tracking Parameter Setting	<ul style="list-style-type: none"> - DVB Detect and Tracking Level Threshold: display / set current detect level threshold and tracking level threshold when DVB tracking mode is chosen to be used. - NBD Detect and Tracking Level Threshold: display / set current detect level threshold and tracking level threshold when NBD tracking mode is chosen to be used. - TX Enable Threshold: display/set TX enable threshold. - Wait time: set the time-out for automatic initiation of a search after the signal level drops below the pre-defined threshold value. - Search Step: set increment step size. - Search 1 & 3 Range: set Search 1 & 3 search range. Search is conducted in a two-axis pattern consisting of alternate movements in azimuth and elevation as forming expanding square. - Search 2 Range: is reserved for future use.
⑨	BUC Keyline Option	Sets Disable or Enable to active BUC Keyline.
⑩	Tilt Sensor Bias	Adjust the two solid-state tilt sensors used to provide absolute cross-level tilt of the antenna and elevation feedback to eliminate long-term pointing drift (error). Tilt bias is required to be adjusted when the antenna control board or sensor box is replaced. Check to see whether or not the bubble is located at the center of the level vial.
⑪	Rate Sensor Adjust	Calibrate DC voltage output from the three rate sensors used to sense antenna motion in azimuth, elevation and cross-level axes. During the calibration process, the antenna should avoid any motion as it can affect the antenna’s performance.



WARNING

WARNING: Tick the checkbox before modifying the settings. After configuration, click 'set...' button to submit the settings.

Tracking Setting

No.	Item	Description
①	Tracking Setting	Display or set current tracking mode and tracking frequency of the target satellite.
②	Local Frequency Setting (MHz)	Display and set LNB's local frequencies. Display current LNB local frequency which is in use and voltage.
③	Current Satellite Setting	Display and set current satellite setting.
④	Tracking Satellite	<p>Display and set current tracking mode.</p> <ul style="list-style-type: none"> - Satellite Name: display and set satellite name. - Longitude: display and set satellite orbit position. - Skew Offset: display and set Skew offset. - Tracking Method: display and set current tracking mode (DVB/ NBD). - RX Polarization: display and set current RX polarization. - TX Polarization display and set current TX polarization.
⑤	DVB Information	<p>Display and set DVB tracking mode's tracking information.</p> <ul style="list-style-type: none"> - Frequency: display and set tracking frequency. - Symbol rate: display and set symbol rate. - NID: display and set network ID. - Verify type: display and set verification type (AGC, DVB, DVB Decode)
⑥	NBD Information	<p>Display and set NBD tracking mode's tracking information.</p> <ul style="list-style-type: none"> - IF Frequency: display and set tracking IF frequency. - Bandwidth: display and set detection bandwidth. - Base Local: displays base local frequency.



WARNING

WARNING: Tick the checkbox before modifying the settings. After configuration, click 'set...' button to submit the settings.

Diagnostic

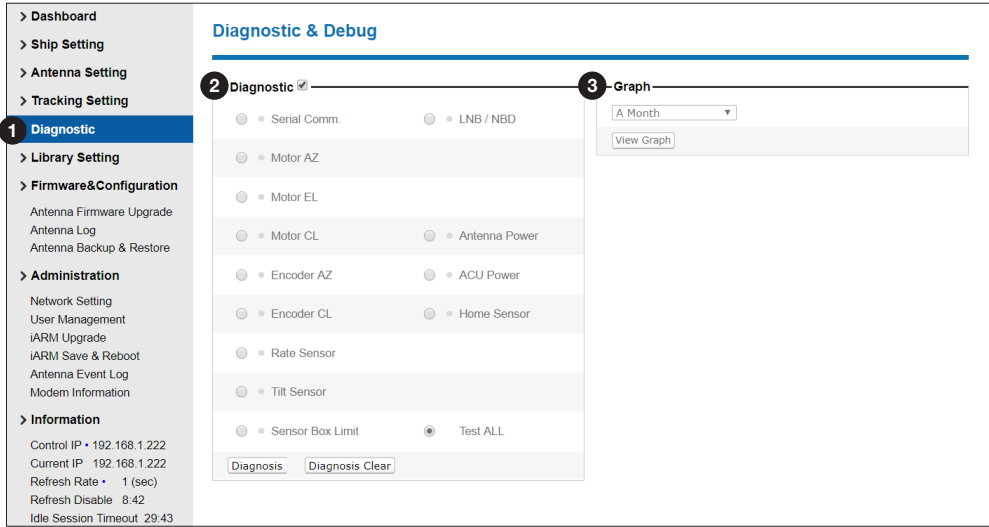

No.	Item	Description
①	Diagnostic	Execute antenna diagnostic test.
②	Diagnostic	<p>Select to run a full diagnostic test or single diagnostic test.</p> <ul style="list-style-type: none"> - Serial Comm.: test the data communication between the antenna and the BDT. - Motor AZ: test the azimuth motor. - Motor EL: test the elevation motor. - Motor CL: test the cross-level motor. - Encoder AZ: test the azimuth encoder. - Encoder CL: test the cross-level encoder. - Rate Sensor: test the rate sensor. - Tilt Sensor: test the tilt sensor. - Sensor Box Limit: test the sensor box motor. - LNB/NBD: test the LNB. - Antenna Power: test the antenna power. - ACU(BDT) Power: test the BDT power. - Home Sensor: test the home sensor - Test ALL: test all devices.
③	Graph	<p>Select to view a graph of AZ Absolute, AZ Relative, EL and Heading data of the antenna.</p> <ul style="list-style-type: none"> - A Month: display all data within a month - A Week: display all data within a week - A Day: display all data in a day - Real-time: display data in real time. Press F5 button to refresh. - Data Num: set the maximum number of graph data set to be displayed. - View Graph: select to view the data graph.

Library Setting

The screenshot shows the 'Library Setting' page in the Aptus Web interface. The left sidebar contains a navigation menu with categories: Dashboard, Ship Setting, Antenna Setting, Tracking Setting, Diagnostic, Library Setting (highlighted), Firmware&Configuration, Administration, and Information. The main content area is titled 'Library Setting' and contains several sections:

- 1 Library Setting:** Includes buttons for 'Get Library from ACU', 'Open Library from PC', 'Upload Library to ACU', and 'Save as Library to PC'. There is also a text input field with the placeholder '파일 선택' and a message '선택된 파일 없음'.
- 2 Library:** A section for managing the satellite library.
- 3 Load Satellite:** A section with a dropdown menu showing 'IOR_062E / 62.5E' and a 'Load Satellite' button.
- 4 Selected Satellite Setting:** A section for configuring the selected satellite, including fields for Satellite Name, Longitude, Skew Offset, Tracking Method, RX Polarization, and TX Polarization.
- 5 Tracking Satellite:** A section for tracking satellite information, including fields for Frequency, Symbol, NID, and Verify Type.
- 6 DVB Information:** A section for DVB tracking mode information, including fields for Frequency, Symbol, NID, and Verify Type.
- 7 NBD Information:** A section for NBD tracking mode information, including fields for Frequency, Bandwidth, and Base Local.
- 8 Local Frequency Setting(MHz):** A section for setting local frequencies, including fields for 13V + 0kHz, 13V + 22kHz, 18V + 0kHz, and 18V + 22kHz.

No.	Item	Description
①	Library Setting	Display and set the satellite library information.
②	Library	<ul style="list-style-type: none"> - Get Library from ACU(BDT): Obtain satellite information installed in the BDT. - Open Library from PC: open the satellite library file from the supplied Intellian CD or from the external hard drive/PC. (File format: *.ilf) - Upload Library to ACU(BDT): upload the satellite library file to BDT. - Save as Library to PC: save the current library setting to the PC.
③	Load Satellite	Select the satellite that you wish to track and press Load Satellite button to load the selected satellite.
④	Selected Satellite Setting	Displays selected satellite information.
⑤	Tracking Satellite	<ul style="list-style-type: none"> - Satellite name: displays satellite name. - Longitude: displays satellite orbit position. - Skew offset: displays Skew offset. - Tracking method: displays current tracking mode (DVB/NBD) - RX polarization: displays current RX polarization. - TX polarization: displays current TX polarization.
⑥	DVB Information	Displays DVB tracking mode's tracking information. <ul style="list-style-type: none"> - Frequency: displays tracking frequency. - Symbol rate: displays symbol rate. - NID: displays network ID. - Verify type: displays verification type (AGC only, DVB lock, DVB decode, DSS decode)
⑦	NBD Information	Displays NBD tracking mode's tracking information. <ul style="list-style-type: none"> - Frequency: displays tracking frequency. - Bandwidth: displays detection bandwidth. - Base Local: displays base local frequency.
⑧	Local Frequency Setting (MHz)	Displays LNB local frequency (MHz) and voltage.

Firmware & Configuration

Antenna Firmware Upgrade

Antenna Firmware Update

1 Antenna Firmware Upgrade
Antenna Log
Antenna Backup & Restore

2 New Antenna Firmware
The update may take a few minutes to complete.
The upload time may vary due to a variety of factors such as the speeds of your network.
Upload an incorrect firmware file may cause serious damage to your antenna and ACU.
Browse and select the firmware file to upload.
파일 선택 | 선택된 파일 없음
Start Upload | Cancel

3 Current Running Version

Current Firmware Version	Antenna STABILIZERv1.05
	Antenna PCU v1.06
	ACU Main v1.06
	Library v5.00

4 Live Rollback

Previous Package Version v161121	Antenna STABILIZERv1.05 Antenna PCU v1.06 ACU Main v1.05	Rollback
Latest Package Version v161121	Antenna STABILIZERv1.05 Antenna PCU v1.06 ACU Main v1.05	Rollback
Factory Default Version v161121	Antenna STABILIZERv1.05 Antenna PCU v1.06 ACU Main v1.05	Rollback

No.	Item	Description
①	Antenna Firmware Upgrade	Upgrade antenna and BDT firmware version.
②	New Antenna Firmware	Browse and select the firmware to upgrade. Clicking Start Upload button will start to upgrade the selected firmware.
③	Current Running Version	Display current firmware version (Antenna STABILIZER, Antenna PCU, ACU(BDT) main, Library)
④	Live Rollback	Display Previous/Latest Package version and rollback firmware to Previous or Latest version. During live rollback, the rollback status is displayed on the Top Menu bar. This helps users control and operate other functions while live rollback is in progress. Once the rollback is complete, the antenna reboots to apply the changes.

Antenna Firmware Upgrade procedures:

1. Click on “Browse” button to select the upgrade package file that you wish to upgrade. Click on the “Start Upload” button to transfer the Firmware package file (“*.fwp”) to iARM module. Wait until the page is loaded.

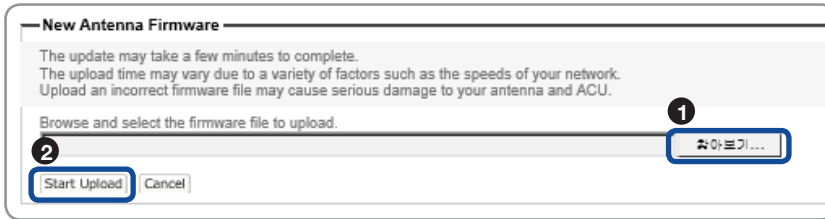

2. After the package file is transferred, it'll show “upgrade from vx.xx Version to vx.xx Version”. Enable the checkbox to select the firmware file that you wish to upgrade.

3. Click on “Start Update” button.

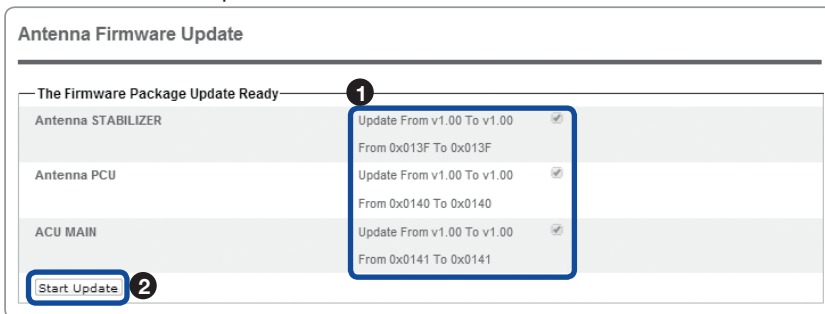

4. During the upgrade process, the window will display process status.

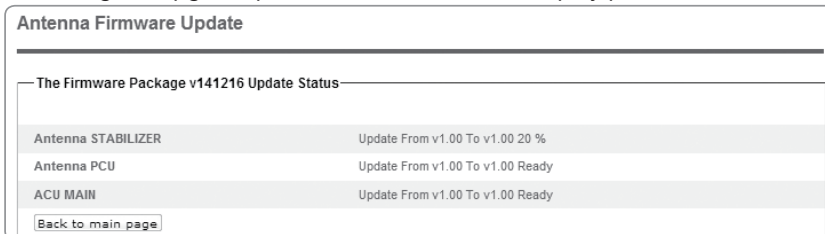

5. If the firmware is successfully upgraded, it will display “The firmware update is completed.”

6. Click on "Back to main page" to go out of the screen.
To verify the upgraded firmware version, go to Dash Board > Software Information.

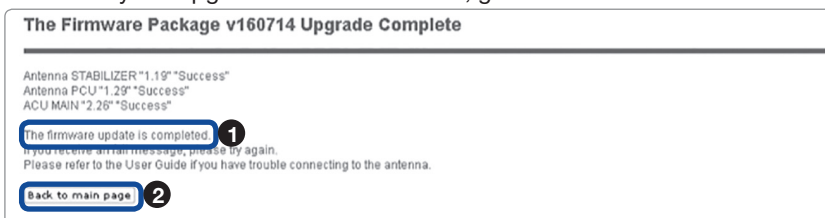

NOTE: To roll back to the previous firmware package version or latest package version, select Rollback Upgrade menu on the Antenna Firmware Upgrade page.

Antenna Log

No.	Item	Description
①	Antenna Log	Displays antenna log data.
②	GPS Log Option	Disable/Enable to save GPS information in the antenna log file.
③	Antenna Log Download	Select file transfer protocol between HTTP Download or FTP Download. For the GX terminals, the default option is HTTP Download. Any log data within 3 months can be downloaded with HTTP Download option selected. Select the start and end date by manual input or mouse-scrolling on the calendar view. Select start download button to proceed. - Start Download: Download the antenna log information. Download the Back up/Report file by clicking the "Include Backup/Restore File" check box.
④	Antenna Firmware Log	Display log information of firmware upgrade.

Log Download using FTP Protocol

In case of using the FTP protocol and attempting to download the log for the first time, Java applications should be installed in your PC/ laptop. Following explains log download procedures using the FTP protocol.

1. Select Download Method as FTP Download and click 'Start Download' button.
2. To run Java applications you must have Java Runtime Environment(JRE) version 6.0 and above installed in your PC/ laptop when you access the antenna log page for first time. Click “Run” button on the popup message “The application’s digital signature cannot be verified. Do you want to run the application?” to install the Applet. Refer to Appendix for Java Installation Instructions if the system does not display the popup message.

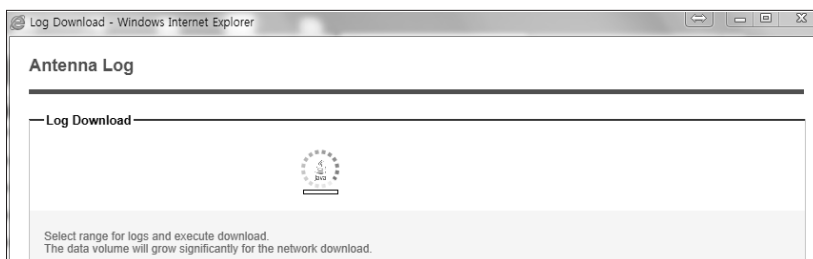

3. Select 'Browse' to browse the target directory of the antenna log file.
4. Select log period for file download.
 - Last 3 Months: download the antenna log information for the past three months.
 - Last 1 Month: download the antenna log information for the past one month.
 - Last 1 week: download the antenna log information for the past one week.
 - Last 1 Day: download the antenna log information for the past one day.
5. Select 'Download' to download the log file to the target directory according to the selected log period.

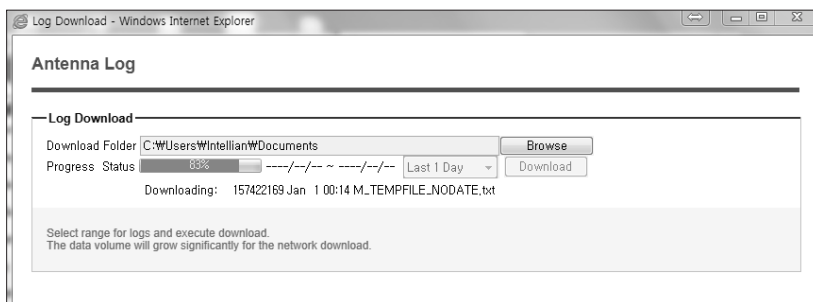

NOTE: You can choose to Enable or Disable the GPS tracking function. Liability for information that is disclosed when GPS is enabled is solely the operators responsibility and it is up to the operator on whether or not to provide their GPS information to third parties. Any issues regarding safety and privacy when turning on the GPS function is solely up to the user. Intellian is not responsible for information that is disclosed when the GPS function is enabled.

Antenna Backup & Restore

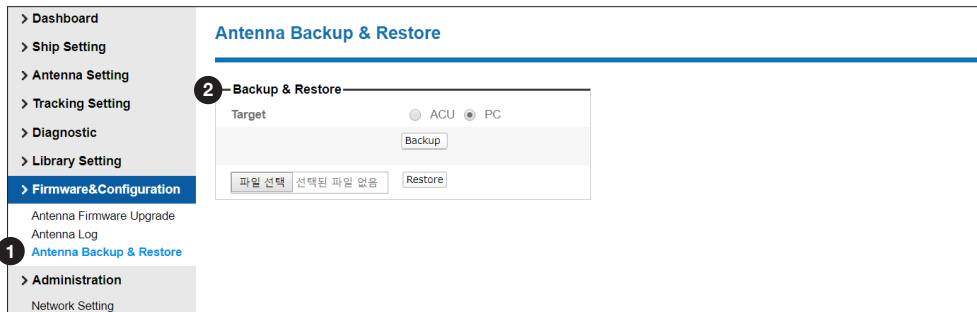

No.	Item	Description
①	Antenna Backup & Restore	Enter Backup & Restore page. (Setup mode is required)
②	Backup & Restore	<ul style="list-style-type: none"> - Target: Backup antenna information to BDT/PC or restore antenna by using the saved information from BDT/PC. - Backup: Backup antenna information. - Restore: Restore antenna information.

Administration

Network Setting

The screenshot shows the 'Network Setting' page with the following sections:

- 1 Administration:** A sidebar menu with options like Dashboard, Ship Setting, Antenna Setting, Tracking Setting, Diagnostic, Library Setting, Firmware & Configuration, and Administration (selected).
- 2 Modem Port Configuration:** Fields for IP Address (192.168.1.2), Subnet Mask (255.255.255.0), Gateway (192.168.1.1), DNS (168.126.63.1), NAT Routing (Enable), TCP Modem Protocol Port (5001), and UDP Modem Protocol Port (49184).
- 3 Management Interface Configuration:** Fields for IP Address (192.168.2.1), Subnet Mask (255.255.255.0), Lease Start Address (192.168.2.2), Lease End Address (192.168.2.30), and Lease Time (180 min).
- 4 WiFi Access Point Configuration:** Fields for SSID (Intellian-GX), Channel (2), Authentication Type (WPA2), Password (Intellian1234), Max Stations (10), and Disable SSID Broadcast (Disable).
- 5 Network Service Configuration:** Fields for Telnet Service (Disable), HTTPS Port (443), and SSH Service (Enable).
- 6 Local Forward to PC Port:** Local Forward (Disable).
- 7 Sys Log Configuration:** Management Server (Disable), Server IP (192.168.1.1), UDP Port (514), Message Type (checkboxes for Error, Major, Periodic, Setting, Minor, Diagnosis, Special, Notice, Reserved), and Syslog Target Level (LOG NOTICE).
- 8 Browser Configuration:** Refresh Rate (1 second), Refresh Disable Time (9 minutes), and a checkbox for 'Set to Current Browser'.
- 9 Dual Diversity Configuration:** Mode (Activate).

No.	Item	Description
①	Network Setting	Enter network setting page.
②	Modem Port Configuration	<p>Modify ACU's Internal IP addresses, routing, and ports. When complete, press "Submit" button at bottom of page. Go to "Save & Reboot" page and press "Save & Reboot" button to validate the changes.</p> <ul style="list-style-type: none"> - IP Address : Factory default(Primary:192.168.1.2)/(Secondary:10.10.1.1). - Subnet Mask : Factory default(255.255.255.0). - Gateway : Factory default(192.168.1.1). - DNS : Current default DNS Address is assigned to. - NAT Routing : Enable/Disable NAT routing. - TCP Modem Protocol Port : TCP port number for modem protocols using TCP as transport. - UDP Modem Protocol Port : UDP port number for modem protocols using UDP as transport.
③	Management Interface Configuration	<p>Modify Management Port's network configuration and press Submit button. Go to "Save & Reboot" page and press Save & Reboot button to validate the changes.</p> <ul style="list-style-type: none"> - IP Address : BDT front network port. Factory default(192.168.2.1). - Subnet Mask : Factory default(255.255.255.0). - Lease Start Address : Lease IP address start range. - Lease End Address : Lease IP address end range. - Lease Time : Lease IP address update time.

④	Wi-Fi Access Point Configuration	<ul style="list-style-type: none"> - SSID : The SSID is the network name shared among all devices in a wireless network. The SSID must be identical for all devices in the wireless network. It is case-sensitive and must not exceed 32 alphanumeric characters, which may be any keyboard character. Make sure this setting is the same for all devices in your wireless network. - Channel : Select an appropriate channel from the list provided to correspond with your network settings. All devices in your wireless network must use the same channel in order to function correctly. Try to avoid conflicts with other wireless networks by choosing a channel where the upper and lower three channels are not in use. - Authentication Type : Module supports an authentication mode that the 802.11 device uses when it authenticates and associates with an access point or IBSS cell. - Password : WiFi access password. - Max Stations : Setting max stations. - Disable SSID Broadcast : Select whether or not to broadcast the SSID in a wireless network. Select Disable to display the network name continuously or select Enable to hide it from the list.
⑤	Network Service Configuration	<ul style="list-style-type: none"> - Telnet Service : Enable or disable telnet login support. - HTTPS Port : HTTPS port number. - SSH Service: Enable or Disable the CLI access through the SSH protocol.
⑥	GX Forward to Local PC Port	<p>To remotely access GX BDT from Intellian's Aptus PC Software, either HTTPS or SSH connection needs to be forwarded. It is recommended to forward less preferred protocol. If "HTTPS" is often used and Aptus PC software is also required, select "SSH to PC". If "SSH" is often used, select "Web to PC".</p>
⑦	Sys Log Configuration	<p>Set the system log configuration. Antenna sends log messages according to emergency level. Enabling this function sends the message to your management server.</p> <ul style="list-style-type: none"> - Management Server : Sys log function enable/disable - Server IP : Management server IP address - UDP Port : Management port - Message Type : Select message type (Intellian message level) to send to management server (Lower number indicates higher emergency). - Sys log Target Level : If you select this target level, the management server receives log message equal to or less than this level.
⑧	Browser Configuration	<p>Setting refresh rate and refresh disable time.</p> <ul style="list-style-type: none"> - Refresh Rate : Set the browser refresh rate (Default 1 seconds. Range 1~99). - Refresh Disable Time : Set the browser idle time-out (Default:9 minutes. Range 0~9). To use this function, check the check box.
⑨	Dual Diversity Configuration	<p>This function is available when the antenna is connected to GX Mediator and GX BDT at the same time.</p> <ul style="list-style-type: none"> - Activate: Select to use the GX Dual Antenna System. The GX BDT will communicate with GX Mediator. For more information about the GX Dual Antenna System, refer to the "GX Mediator User Guide" that came with the GX Mediator package. - Inactivate: Select to use the GX Single Antenna System.

User Management

> Dashboard

> Ship Setting

> Antenna Setting

> Tracking Setting

> Diagnostic

> Library Setting

> Firmware&Configuration

Antenna Firmware Upgrade

Antenna Log

Antenna Backup & Restore

> Administration

Network Setting

1 User Management

iARM Upgrade

iARM Save & Reboot

Antenna Event Log

Modem Information

> Information

Control IP • 192.168.1.222

Current IP 192.168.1.222

Refresh Rate • 1 (sec)

Refresh Disable 8:38

Idle Session Timeout 29:39

Time 07:22:11 (UTC)

Date 2017-11-30

Wifi

User Management

2 Change ID & Password

Change ID

Current ID

New ID

Change Password

Enter Current Password

Enter New Password

Confirm New Password

3 Change User Settings

Password Expire Timeout

Timeout in days day

Idle Session Timeout

for Console login min

for Network login min

Guest Session Access

Allow Connections

No.	Item	Description
①	User Management	Change login ID and Password to access the Aptus Web. This setting can be also accessed by 'Account' icon on the top menu.
②	Change ID & Password	<p>Change your login ID (user name) and password.</p> <ul style="list-style-type: none"> - Change ID : Enter your current login ID (user name) and new login ID. Click the Submit button to validate the changes that are made to the login ID. - Change Password : Enter your current login password and new login password. Click the Submit button to validate the changes that are made to the login password. <p>Note: New login password will be disallowed in the following cases.</p> <ul style="list-style-type: none"> • Common dictionary words • Too short password • If not a combination of letters, numbers and special characters • Recently used password
③	Change User Settings	<p>Change User Password Expire in days and Idle session timeout.</p> <ul style="list-style-type: none"> - Password Expire Timeout : Set password expire in days. - Idle Session Timeout : Set for Console and for Network timeout. - Guest Session Access: Set up the guest access option.

iARM Upgrade

- > Dashboard
- > Ship Setting
- > Antenna Setting
- > Tracking Setting
- > Diagnostic
- > Library Setting
- > Firmware&Configuration
 - Antenna Firmware Upgrade
 - Antenna Log
 - Antenna Backup & Restore
- > Administration
 - Network Setting
 - User Management
 - iARM Upgrade
 - iARM Save & Reboot
 - Antenna Event Log
 - Modem Information
- > Information
 - Control IP : 192.168.1.222
 - Current IP : 192.168.1.222
 - Refresh Rate : 1 (sec)
 - Refresh Disable : 8.35
 - Idle Session Timeout : 29:36
 - Time : 07:22:58 (UTC)
 - Date : 2017-11-30
 - Wifi

iARM Upgrade

2 New iARM Firmware

Ignore warnings during installation and force the installation to continue

Browse and select the firmware file to upload.

3 Bootstrap/Bootloader

Bootstrap	Main	v1.05
	Factory Default	v1.05
Bootloader	Main	v1.00
	Factory Default	v1.00
	Active Bootloader	Main

4 Kernel/File System

Sys0	Kernel	v1.75	
	File System	v1.40	<input type="button" value="Activate"/>
Sys1	Kernel	v1.75	
	File System	v1.40	<input type="button" value="Activate"/>
Factory Default	Kernel	v1.75	
	File System	v1.03	<input type="button" value="Activate"/>
Current Active	Sys1		
	Active Kernel	v1.75	
	Active File System	v1.40	

No.	Item	Description
①	iARM Upgrade	Upgrade the firmware of iARM module.
②	New iARM Firmware	Browse and select the firmware file to upload and click Start Upgrade button.
③	Bootstrap /Bootloader	Displays current bootstrap and bootloader version.
④	Kernel /File System	BDT has 3 storage parts sys0, sys1, Factory Default. Display kernel and file system version and current activated part Information.

108

iARM firmware upgrade procedures:

1. Click on "Browse" button to select the the iARM firmware file (.tgz) that you wish to upgrade. Click on the "Start Upload" button to transfer the to update the iARM firmware. Wait until the page is loaded.

NOTE: When checking the box "Ignore warnings during installation and force the installation to continue" before performing the upgrade, the warning messages do not appear during the upgrade.

2. Once update starts, a page will indicate upgrade status. Do not turn off the device power if the firmware upgrade page is displayed. It should take around 2 minutes to complete the firmware upgrade.

3. Once the upgrade is completed, the system will reboot automatically.

iARM Save & Reboot

No.	Item	Description
①	iARM Save & Reboot	Save settings to the ACU and reboot or reboot the system without saving.
①	Save & Reboot	Save the modified settings and reboot the system. Click the "Save & Reboot" button.
②	Reboot without Saving	Reboot the system without saving the modified settings. Click the "Reboot Only" button.

Antenna Event Log

- > Dashboard
- > Ship Setting
- > Antenna Setting
- > Tracking Setting
- > Diagnostic
- > Library Setting
- > Firmware&Configuration
 - Antenna Firmware Upgrade
 - Antenna Log
 - Antenna Backup & Restore
- 1 > Administration
 - Network Setting
 - User Management
 - iARM Upgrade
 - iARM Save & Reboot
 - Antenna Event Log
 - Modem Information
- > Information
 - Control IP • 192.168.1.222
 - Current IP 192.168.1.222
 - Refresh Rate • 1 (sec)
 - Refresh Disable 8:41
 - Idle Session Timeout 29:42
 - Time 07:24:28 (UTC)
 - Date 2017-11-30
 - Wifi

Antenna Event Log

2 Query Filter

Severity: All Category: All

Time Frame: Last 1 Day Sorting Order: Descending Ascending

3 Event Log

Date/Time(UTC)	Severity	Category	Log	<input type="button" value="Save Event Log"/>
2017-11-30 07:21:07	Normal	Access	Remote Login through CLI from 127.0.0.1 using ID root	
2017-11-30 07:03:06	Normal	Access	Remote Control Login through WEB from 192.168.1.222 using ID Intellian	
2017-11-30 06:55:23	Critical	System	[H1] Active Antenna:Ant2->Ant1 (Manual)	
2017-11-30 06:55:21	Critical	System	[H1] Active Antenna:Ant1->Ant2 (FAULT)	
2017-11-30 06:55:16	Critical	System	[H1] Active Antenna:Ant2->Ant1 (FAULT)	
2017-11-30 06:55:10	Critical	System	[H1] Active Antenna:Ant1->Ant2 (FAULT)	
2017-11-30 06:55:05	Critical	System	[H1] Active Antenna:Ant2->Ant1 (FAULT)	
2017-11-30 06:54:59	Critical	System	[H1] Active Antenna:Ant1->Ant2 (FAULT)	
2017-11-30 06:54:54	Critical	System	[H1] Active Antenna:Ant2->Ant1 (FAULT)	
2017-11-30 06:54:48	Critical	System	[H1] Active Antenna:Ant1->Ant2 (FAULT)	
2017-11-30 06:54:43	Critical	System	[H1] Active Antenna:Ant2->Ant1 (FAULT)	
2017-11-30 06:54:37	Critical	System	[H1] Active Antenna:Ant1->Ant2 (FAULT)	
2017-11-30 06:54:32	Critical	System	[H1] Active Antenna:Ant2->Ant1 (FAULT)	
2017-11-30 06:54:26	Critical	System	[H1] Active Antenna:Ant1->Ant2 (FAULT)	
2017-11-30 06:54:21	Critical	System	[H1] Active Antenna:Ant2->Ant1 (FAULT)	
2017-11-30 06:54:15	Critical	System	[H1] Active Antenna:Ant1->Ant2 (FAULT)	

No.	Item	Description
①	Antenna Event Log	Displays the antenna system and user log information by setting urgency level.
②	Query Filter	Set the Log message option. - Severity : Set urgency level. - Category : Set target that caused the message. - Time Frame : Set time limit that you want to show. - Sorting Order : Sorting based on date(descending or ascending).
③	Event Log	Displays log information (Date/Time, Severity, Category, Log). - Save Event Log : Save log message to your PC.

110

Modem Information

No.	Item	Description
①	Modem Information	Display modem's operating status and information.
②	Modem	Display modem's operating status.
③	LED Status	<p>Each dots are displayed status as colors.</p> <ul style="list-style-type: none"> - NET: Displays the network status. (Green: Indicates that the modem has been acquired into the network. Flashing green: Indicates that the modem is in network acquisition.) - STATUS: Displays the modem status.(Green: modem is functioning properly. Flashing green: Indicates that the modem is booting. Red: Indicates a serious fault or failure in software, hardware, or configuration in modem.) - TX: Displays TX enable status.(Green: Indicates that the modem transmitter is enabled. Yellow: Indicates that the modem transmitter is disabled.) - RX1/2: Displays the modem lock status of RX path 1/2.(Green: Indicates that the modem receiver 1 or 2 is successfully locked to the downstream. Yellow: Indicates that the modem receiver 1 or 2 is not locked to the downstream carrier.)
④	Satellite Status	Display the receive 1/2 SNR(dB) of the satellite.
⑤	Modem Information	Display modem information. (Terminal Type, Serial Number and Software Version)
⑥	Modem Reboot	Sets the modem reboot.
⑦	One Touch Commissioning	<p>Sets the One Touch Commissioning(OTC) for calibration of antenna's BUC.</p> <ul style="list-style-type: none"> - Status: Displays the current OTC status. - Start/Stop: Sets Calibration Start/Stop. <p>NOTE: Ensure to perform One-touch Commissioning after the first-time connection of the GX terminal and the BDT, cable replacement or Band conversion.</p>
⑧	VLAN Configuration	Displays the assigned port and IP address of VLAN. (UserPort Number, Assigned IP(Gateway), Assigned Netmask, Available Start IP, Available End IP)

Technical Specification

Dimensions	
Satellite antenna unit	90cm x 103cm (35.5" x 40.5")
Antenna dish diameter	65cm (25.6")
Below Deck Terminal	43.1cm x 44.1cm x 4.4cm (17" x 17.3" x 1.7")
Weight	
Satellite antenna unit	60kg (132lbs)
Below Deck Terminal	4kg (8.8lbs)
Antenna system	
Tx Frequency	29.00~30GHz Ka-band
Tx Gain	43.75dBi @ 29.5GHz (with radome)
Rx Frequency	19.2~20.2GHz Ka-band
Rx Gain	40 dBi @ 19.7GHz (with radome)
Polarized Feed	Circular, Tx:RHCP Rx:LHCP
G/T	17 dB/K (Typ.)
Azimuth Range	Unlimited
Elevation Range	-20° ~ +115°
Cross-level Range	±37°
Stabilization Accuracy	0.2° peak mis-pointing @ max ship motion condition
Max Ship's motion	±25°roll, ±15° pitch, ±8°yaw@ 6 sec
BUC	5W Ka-band BUC
Power Consumption	100 ~ 240 V AC, 50 ~ 60Hz, 4A
Operating temperature range	-25°C to 55°C
Storage temperature range	-40°C to 80°C
Below Deck Terminal	
Dimensions (WxDxH)	43.1cm x 44.1cm x 4.4cm / 17" x 17.3" x 1.7"
Weight	4kg / 8.8lbs
Display	2 line 40 character graphic VFD module
Ship's Gyrocompass Interface	NMEA 2000 / NMEA 0183
Modem Interface	Integrated on the BDU
Remote Management	Yes
Wi-Fi Operation	Yes
Management Port	Yes (Ethernet/ USB/ Serial)
Power Requirement	100~240V AC, 50~60Hz, 1A

Warranty

This product is warranted by Intellian Technologies Inc., to be free from defects in materials and workmanship for a period of THREE (3) YEARS on parts and TWO (2) YEARS on labor performed at Intellian Technologies, Inc. service center from the purchased date of the product.

Intellian Technologies, Inc. warranty does not apply to product that has been damaged and subjected to accident, abuse, misuse, non-authorized modification, incorrect and/ or non-authorized service, or to a product on which the serial number has been altered, mutilated or removed.

It is required to present a copy of the purchase receipt issued by Intellian Technologies, Inc. that indicates the date of purchase for after-sales service under the warranty period. In case of failure to present the purchase receipt, the warranty period will begin 30 days after the manufacturing production date of the product purchased.

Any product which is proven to be defective in materials or workmanship, Intellian Technologies, Inc. will (at its sole option) repair or replace during the warranty period in accordance with this warranty. All products returned to Intellian Technologies, Inc. under the warranty period must be accompanied by a return material authorization (RMA) number issued by the dealer/distributor from Intellian Technologies, Inc. and a copy of the purchase receipt as a proof of purchased date, prior to shipment. Alternatively, you may bring the product to an authorized Intellian Technologies, Inc. dealer/distributor for repair.

Additional Terms and Conditions:

The warranty(THREE (3) YEARS on parts and TWO (2) YEARS on labor) is effective only for products purchased since January 1st, 2017.